

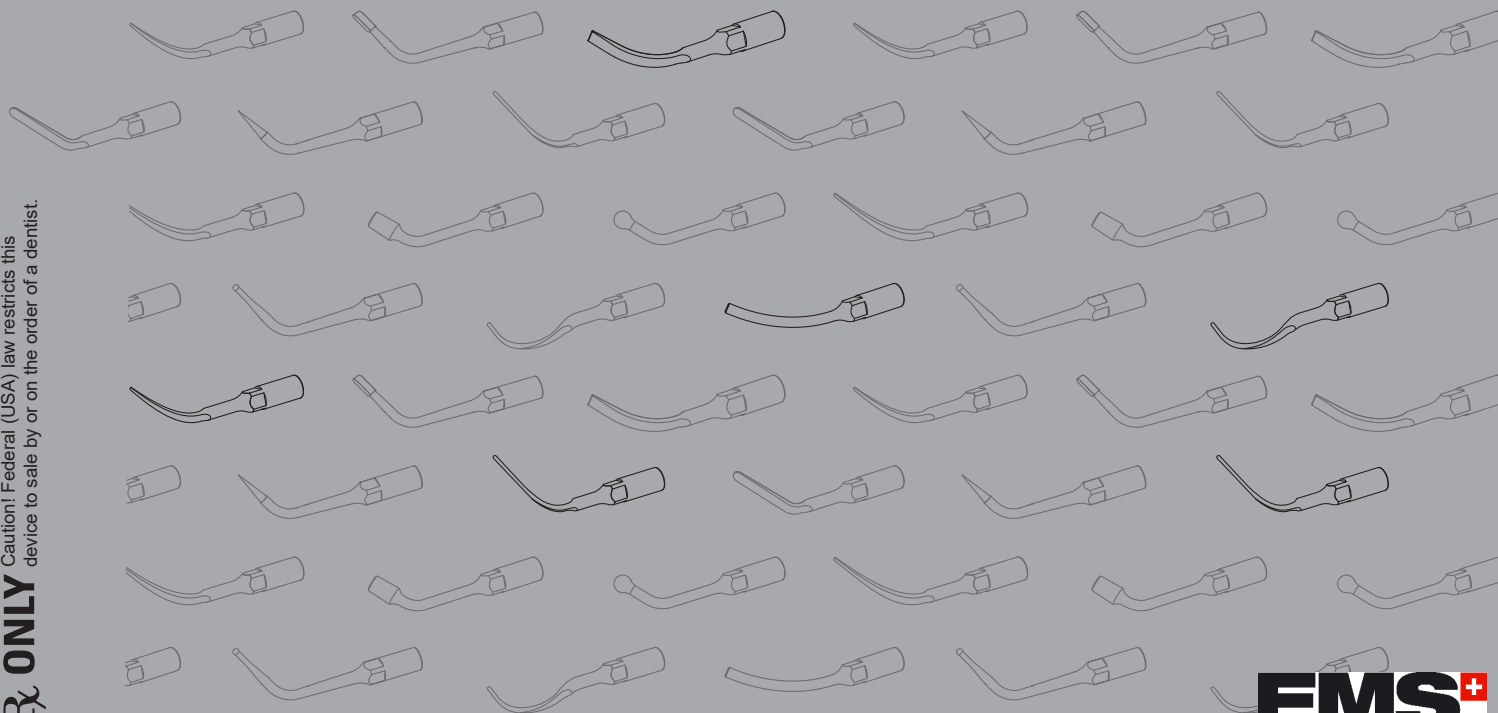

OPERATION INSTRUCTIONS
 UPUTE ZA RUKOVANJE
 GEBRUIKSAANWIJZING
 INSTRUÇÕES DE UTILIZAÇÃO
 BETJENINGSVEJLEDNING
 BRUKSANVISNING

Piezon® Systems

PIEZON CLASSIC INSTRUMENTS



Rx ONLY Caution! Federal (USA) law restricts this device to sale by or on the order of a dentist.



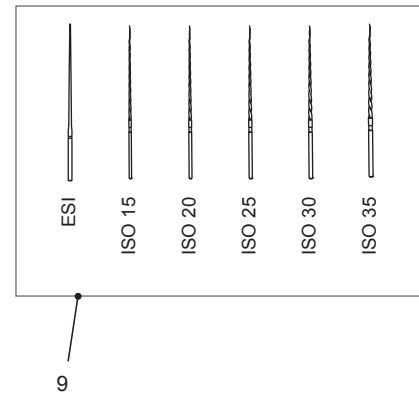
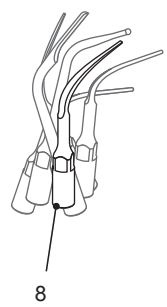
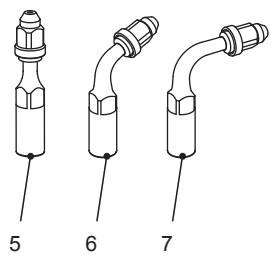
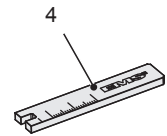
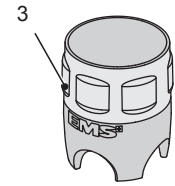
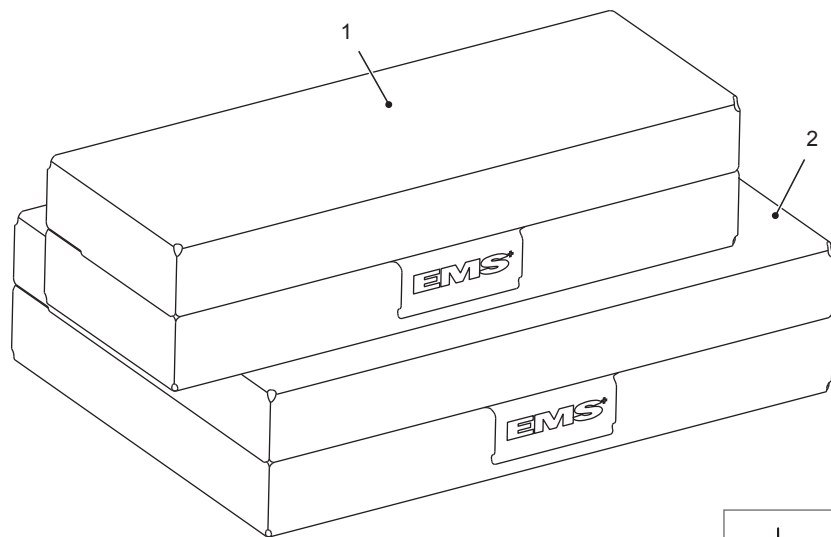



COMPONENTS

- 1 SystemBox ¼ DIN
- 2 SystemBox ½ DIN
- 3 CombiTorque®
- 4 Flat wrench for file holders
- 5 File holder 180°
- 6 File holder 120°
- 7 File holder 90°
- 8 Instruments (typical shown)
- 9 K-type and ESI files
- 10 File container

The packing list shows what instruments and accessories are included in this system. To complete this set, instruments and accessories may be ordered individually or by set through your EMS dealer.

KOMPONENTE

- 1 SystemBox ¼ DIN
- 2 SystemBox ½ DIN
- 3 Kombinirani ključ (CombiTorque®)
- 4 Ravni ključ za držače za igle
- 5 Držač za igle 180°
- 6 Držač za igle 120°
- 7 Držač za igle 90°
- 8 Instrumenti (pokazani su tipični)
- 9 Igle K tipa i ESI igle
- 10 Posuda za igle

Popis na pakovanju prikazuje koji instrumenti i dodaci su uključeni u ovaj sustav. Kako biste dopunili ovaj komplet, moguće je pojedinačno ili u kompletu naručiti instrumente i dodatke od vašeg EMS trgovca.

ONDERDELEN

- 1 SystemBox ¼ DIN
- 2 SystemBox ½ DIN
- 3 CombiTorque®
- 4 Platte sleutel voor vijlhouders
- 5 Vijlhouder 180°
- 6 Vijlhouder 120°
- 7 Vijlhouder 90°
- 8 Instrumenten (standaard afgebeeld)
- 9 K-vijlen en ESI-vijlen
- 10 Vijlcontainer

De verpakkingslijst laat zien welke instrumenten en accessoires dit systeem bevat. Om deze set aan te vullen, kunnen instrumenten en accessoires afzonderlijk of per set via uw EMS-dealer worden besteld.

COMPONENTES

- 1 SystemBox ¼ DIN
- 2 SystemBox ½ DIN
- 3 CombiTorque®
- 4 Chave de fendas para porta-limas
- 5 Porta-limas 180°
- 6 Porta-limas 120°
- 7 Porta-limas 90°
- 8 Instrumentos (ilustração genérica)
- 9 Limas tipo K e ESI
- 10 Caixa para limas

A "packing list" mostra quais os instrumentos e acessórios incluídos neste sistema. Para completar este conjunto, os instrumentos e acessórios podem ser encomendados individualmente ou em conjuntos através do seu revendedor EMS.

KOMPONENTER

- 1 SystemBox ¼ DIN
- 2 SystemBox ½ DIN
- 3 CombiTorque®
- 4 Flad skruenøgle til filholdere
- 5 Filholder 180°
- 6 Filholder 120°
- 7 Filholder 90°
- 8 Instrumenter (typisk vist)
- 9 K- og ESI-filer
- 10 Filbeholder

Pakkelisten viser de instrumenter og det tilbehør, der er inkluderet i dette system. Du kan komplettere dette sæt ved at bestille instrumenter og tilbehør individuelt eller i sæt gennem din EMS-forhandler.

DELER

- 1 SystemBox ¼ DIN
- 2 SystemBox ½ DIN
- 3 CombiTorque®
- 4 Flad nøkkel til filholdere
- 5 Filholder 180°
- 6 Filholder 120°
- 7 Filholder 90°
- 8 Instrumenter (generell illustrasjon)
- 9 K- og ESI-filer
- 10 Filbeholder

Pakkelisten viser hvilke instrumenter og tilbehør som inngår i dette systemet. For å komplettere settet kan instrumenter og tilbehør bestilles enkeltvis eller settvis hos EMS-forhandleren.





Scaling

Endo



Resto

Perio

Endo files





DEAR CUSTOMERS,

Thank you for buying a new EMS Piezon system. It meets the highest quality and safety standards.

Indications

EMS offers a wide range of Piezon ultrasound instruments for use in dentistry with an EMS Piezon ultrasound unit. Long thin instruments allow for easy access to periodontal pockets and interproximal areas. Piezon instruments are available for the following indications:

Scaling

- Removal of supragingival calculus
- Removal of stains

Endo

- Preparation, cleaning and irrigation of root canals
- Retrograde preparation of root canals
- Condensing gutta-percha
- Removal of crowns, bridges and restorations

Restorative

- Preparation of cavities
- Cementation of restorations
- Condensing of amalgams

Periodontics

- Scaling and root planing
- Periodontal therapy

Contraindications

 EMS recommends not to treat patients with a cardiac pacemaker or a defibrillator with this product. The functionality of these devices may be affected by the high frequencies of the ultrasonic oscillations.

POŠTOVANI KLIJENTI,

Zahvaljujemo na kupnji novog EMS Piezon sustava. Ovaj proizvod zadovoljava najviše standarde kvalitete i sigurnosti.

Indikacije

EMS nudi široki spektar Piezon ultrazvučnih instrumenata za korištenje u stomatologiji zajedno s EMS Piezon ultrazvučnom jedinicom. Dugi, uski instrumenti omogućuju jednostavan pristup parodontalnim džepovima i interproksimalnim područjima. Piezon instrumenti koriste se za sljedeće indikacije:

Uklanjanje zubnog kamenca

- Uklanjanje supragingivnog kamenca
- Uklanjanje mrlja

Endodonticija

- Priprema, čišćenje i ispiranje korijenskih kanala
- Retrogradna priprema korijenskih kanala
- Kondenzacija gutaperkom
- Uklanjanje kruna, mostova i ispuna

Restauracija

- Priprema šupljina
- Cementiranje restauracija
- Kondenzacija amalgama

Parodontologija

- Uklanjanje kamenca i kiretaža
- Parodontološka terapija

Kontraindikacije

 EMS preporuča da ne tretirate ovim proizvodom pacijente s pacemakerom ili defibrilatorom. Funkcionalnost ovih uređaja može biti smanjena zbog visokih frekvencija ultrazvučnih oscilacija.

GEACHTE KLANT,

Vriendelijk dank voor het aanschaffen van dit nieuwe EMS Piezon-systeem. Het voldoet aan de hoogste kwaliteits- en veiligheidsnormen.

Indicaties

EMS biedt een zeer uiteenlopend assortiment Piezon ultrasone instrumenten voor gebruik met een EMS Piezon ultrasoon apparaat in de tandheelkundige praktijk. Lange dunne instrumenten maken gemakkelijke toegang tot pockets en interproximale ruimten mogelijk. Piezon-instrumenten zijn verkrijgbaar voor de volgende indicaties:

Scaling

- Verwijdering van supragingivale tandsteen
- Verwijdering van verkleuringen

Endo

- Preparatie, reiniging en irrigatie van wortelkanalen
- Retrograde preparatie van wortelkanalen
- Condenseren van gutta percha
- Verwijdering van kronen, bruggen en restauraties

Restauratie

- Preparatie van caviteiten
- Cementering van restauraties
- Condenseren van amalgamen

Parodontie

- Scaling en rootplaning
- Parodontale behandeling

Contra-indicaties

 EMS beveelt aan patiënten met een cardiale pacemaker of defibrillator niet met dit apparaat te behandelen. Door de hoge frequenties van de ultrasone trillingen kan de functionaliteit van deze hulpmiddelen negatief worden beïnvloed.





CAROS CLIENTES,

Agradecemos a aquisição de um novo sistema EMS Piezon que cumpre as mais rigorosas normas de qualidade e segurança.

Indicações

A EMS disponibiliza uma vasta gama de instrumentos ultrassônicos Piezon para utilização em estomatologia com uma unidade de ultrassons EMS Piezon. Os instrumentos compridos e finos permitem um acesso fácil às bolsas periodonticas e áreas interproximais. Os instrumentos Piezon estão disponíveis para as seguintes indicações:

Destartarização

- Remoção de tártaro supragengival
- Remoção de manchas

Endodontia

- Preparação, limpeza e irrigação de canais radiculares
- Preparação retrógrada de canais radiculares
- Condensação de gutta-percha
- Remoção de coroas, pontes e reconstruções

Reconstrução

- Preparação de cavidades
- Cimentação de reconstruções
- Condensação de amálgamas

Periodontia

- Destartarização e alisamento radicular
- Terapia periodontica

Contra-indicações

 A EMS recomenda que os pacientes com um pacemaker ou desfibrilhador cardíaco não sejam tratados com este produto. O funcionamento destes dispositivos pode ser afectado pelas altas frequências das vibrações ultrassónicas.

KÆRE KUNDER,

Tak, fordi I har købt et nyt EMS Piezon-system. Det opfylder de højeste kvalitets- og sikkerhedsstandarder.

Indikationer

EMS tilbyder en lang række Piezon-ultralydsinstrumenter til brug i tandlægearbejdet med en EMS Piezon-ultralydsenhed. Lange tynde instrumenter muliggør let adgang til parodontale lommer og interproximale områder. Piezon-instrumenter leveres til følgende indikationer:

Tandrensning

- Fjernelse af supragingival calculus
- Fjernelse af pletter

Endodonti

- Præparation, rensning og skylning af rodkanaler
- Retrograd præparation af rodkanaler
- Kondenserende gutta-percha
- Fjernelse af kroner, broer og rekonstruktioner

Restorativ behandling

- Præparation af kaviteter
- Cementering af rekonstruktioner
- Kondensering af amalgam

Parodonti

- Tandrensning og rodplanering
- Parodontal behandling

Kontraindikationer

 EMS fraråder at behandle patienter, der har en pacemaker eller en defibrillator, med dette produkt. Varmen, der genereres af de høje frekvenser i instrumentspidsen, blødgør gutta-percha'en og maksimerer lateral gennemstrømning i rodkanalsystemet.

KJÆRE KUNDE

Takk for at du har kjøpt et nytt Piezon-system fra EMS. Det oppfyller de høyeste standardene for kvalitet og sikkerhet.

Indikasjoner

EMS tilbyr et stort utvalg av Piezon-ultralydinstrumenter til tannmedisinsk bruk sammen med en EMS Piezon-ultralydenhet. De lange, tynne instrumentene gir enkel tilgang til periodontale lommer og interproximale områder. Piezon-instrumenter fås til følgende indikasjoner:

Scaling

- Fjerning av supragingival tannstein
- Fjerning av flekker

Endodonti

- Preparering, rensing og spyling av rotkanaler
- Retrograd preparering av rotkanaler
- Kondensering av guttaperka
- Fjerning av kroner, broer og rekonstruksjoner

Restorativ behandling

- Preparering av kaviteter
- Sementering av rekonstruksjoner
- Kondensering av amalgam

Periodonti

- Scaling og rotplaning
- Periodontibehandling

Kontraindikasjoner

 EMS anbefaler at pasienter med hjertepacemaker eller defibrillator ikke behandles med dette produktet. Slike apparater kan bli påvirket av ultralydsvingningenes høye frekvenser.







PIEZON CLASSIC

 These ranges of Piezon instruments must not be used with an EMS Piezon Master Surgery® unit.

 The EMS Piezon family includes several specific CombiTorque. It is mandatory to always use the correct CombiTorque with the corresponding instruments and handpiece. The CombiTorque are easily identified by their body color as follows:

- Yellow CombiTorquePiezon CLASSIC
- Blue CombiTorque.....Piezon SURGERY

 Make sure that only compatible components are used for installation and removal of the instruments to avoid damaging this equipment.

 The illustrations in these instructions represent generic components; however these instructions apply to the Piezon CLASSIC range of instruments (unless otherwise specified).

 The markings on the instruments indicate their type as listed in this manual.

PIEZON CLASSIC

 Ove vrste Piezon instrumenata ne smiju se koristiti s EMS Piezon Master Surgery® jedinicom.

 EMS Piezon spektar proizvoda uključuje nekoliko posebnih kombiniranih ključeva (CombiTorque). Obavezno treba koristiti ispravni kombinirani ključ (CombiTorque) s odgovarajućim instrumentima i nasadnikom. Kombinirani ključ (CombiTorque) lako je prepoznati po njegovom tijelu i boji, kako slijedi:

- Žuti kombinirani ključPiezon CLASSIC
- Plavi kombinirani ključ (CombiTorque).....Piezon SURGERY

 Osigurajte da se koriste samo kompatibilne komponente za postavljanje i uklanjanje instrumenata kako bi se izbjegla oštećenja opreme.

 Ilustracije u ovim korisničkim uputama predstavljaju generičke komponente; ove upute međutim odnose se na Piezon CLASSIC spektar instrumenata (osim ako nije drugačije navedeno).

 Oznake na instrumentima označavaju njihov tip kako je navedeno u korisničkom priručniku.

PIEZON CLASSIC

 Deze Piezon-instrumenten mogen niet worden gebruikt met een EMS Piezon Master Surgery®-apparaat.

 De EMS Piezon-lijn omvat een aantal specifieke CombiTorques. Het is noodzakelijk altijd de juiste CombiTorque te gebruiken met de bijbehorende instrumenten en handstuk. De CombiTorques kunnen gemakkelijk worden onderscheiden aan de hand van de kleur van de behuizing:

- gele CombiTorque.....Piezon CLASSIC
- blauwe CombiTorquePiezon SURGERY

 Zorg ervoor dat uitsluitend compatibele onderdelen worden gebruikt voor plaatsing en verwijdering van de instrumenten om schade aan de apparatuur te voorkomen.

 De illustraties in deze instructies geven generieke onderdelen weer; deze instructies zijn echter van toepassing op het assortiment instrumenten van Piezon CLASSIC (tenzij anders aangegeven).

 De markeringen op de instrumenten geven het type aan zoals vermeld in deze handleiding.







PIEZON CLASSIC

 Este gama dos instrumentos Piezon não devem ser utilizados com EMS Piezon Master Surgery® unit.

 A familia de EMS Piezon tem varios CombiTorque especificos. E obrigatorio de usar o CombiTorque corecto com o instrumento ou peça de mao corespondante. Os CombiTorque podem ser identificados facilmente com a sua core.

- (Amarello) Yellow CombiTorque: Piezon CLASSIC
- (Azul) Blue CombiTorque: Piezon SURGERY

 Tenha certeza que você utiliza componentes compatíveis para a instalação, montagem e desmontagem dos instrumentos para evitar danificar este equipamento.

 As ilustrações deste manual apresentam componentes genericos; de todas as maneiras aqueles instruções applicam-se gama de instrumentos Piezon Classic (a menos que indicado em contrário)

 As marcações nos instrumentos indicam o seu tipo listado neste manual.

PIEZON CLASSIC

 Disse Piezon-instrumenter må ikke anvendes sammen med en EMS Piezon Master Surgery®-enhet

 EMS Piezon-familien omfatter adskillige specielle CombiTorque-typer. Det er obligatorisk altid at anvende den korrekte type CombiTorque med de tilsvarende instrumenter og håndstykke. CombiTorque-typerne er lette at identificere på deres kropsfarve, der er som følger:

- Gul CombiTorquePiezon CLASSIC
- Blå CombiTorque.....Piezon SURGERY

 Sørg for, at der kun anvendes kompatible komponenter til installation og fjernelse af instrumenterne for at undgå at beskadige dette udstyr.

 Illustrationerne i disse instruktioner repræsenterer generiske komponenter. Disse instruktioner gælder imidlertid for Piezon CLASSIC-instrumenter (medmindre andet er angivet).

 Markeringerne på instrumenterne indikerer deres type, som den er angivet i denne vejledning.

PIEZON CLASSIC

 Disse Piezon-instrumentene må ikke brukes sammen med en EMS Piezon Master Surgery®-enhet.

 EMS Piezon-familien består av flere spesi- fikke CombiTorque. Riktig CombiTorque må alltid brukes sammen med tilsvarende instrumenter og håndstykke. Hver CombiTorque kan enkelt identi- fiseres med fargen på selve instrumentet:

- Gul CombiTorquePiezon CLASSIC
- Blå CombiTorque.....Piezon SURGERY

 For å unngå å skade dette utstyret må det kun brukes kompatible deler ved installering og fjerning av instrumentene.

 Figurene i denne bruksanvisningen viser generiske komponenter, bruksanvisningen gjelder imidlertid Piezon CLASSIC-instrumentene (hvis ikke annet er angitt).

 Merkingen på instrumentene angir hvilken type dreier seg om (som angitt i denne håndboken).





ABOUT THIS MANUAL

These operating instructions are to ensure the correct installation and use of this product.

Please read these operating instructions carefully as they explain all the most important details and procedures. Please pay special attention to the safety precautions.

Always keep this document close at hand.

To prevent injury to people and damage to property, please heed the corresponding directives. They are marked as follows:



Danger

Risk of patient or user injury



Caution

Risk of damage to the device or environmental harm



Please note

Useful additional information and hints



Prohibited



Authorized



Instructions concerning the components of the system are provided separately in the relative instructions for use. Read the instruction manuals delivered with each of the components before using this product. Do not hesitate to contact your local EMS dealer for further information.

O OVOM PRIRUČNIKU

Namjena je ovih uputa za rukovanje osiguranje ispravne instalacije i uporabe ovog proizvoda.

Pažljivo pročitatite ove upute za rad jer su u njima objašnjene najvažnije pojedinosti i postupci. Posebnu pozornost obratite na sigurnosne mjere.

Ovaj dokument uvijek držite pri ruci.

Da biste spriječili ozljede i oštećenje imovine, pridržavajte se odgovarajućih upozorenja. Upozorenja su označena sljedećim simbolima:



Opasnost

Opasnost od ozljede pacijenta ili korisnika



Oprez

Opasnost od oštećenja uređaja ili opasnost za okoliš



Napomena

Korisne dodatne informacije i savjeti



Zabranjeno



Dopušteno



Upute koje se odnose na komponente sustava isporučuju se odvojeno u odgovarajućim uputama za uporabu. Prije korištenja ovog proizvoda pročitatite priručnike koji se isporučuju sa svakom komponentom. Za više informacija slobodno se obratite svom lokalnom distributeru tvrtke EMS.

OVER DEZE HANDLEIDING

Deze gebruiksaanwijzing dient om een juiste installatie en toepassing van dit product te garanderen.

Lees deze gebruiksaanwijzing aandachtig door omdat hierin de belangrijkste details en procedures worden uitgelegd. Let extra goed op de voorzorgsmaatregelen voor de veiligheid.

Houd dit document altijd onder handbereik.

Volg de betreffende richtlijnen om letsel aan personen en schade aan eigendommen te voorkomen. Ze worden als volgt aangegeven:



Gevaar

Risico van letsel bij patiënt of gebruiker



Waarschuwing

Risico van schade aan het apparaat of milieu



Let op

Nuttige extra informatie en tips



Verboden



Toegestaan



Instructies voor de onderdelen van het systeem worden afzonderlijk vermeld in de betreffende gebruiksinstructies. Lees de gebruikshandleidingen die met elk van de onderdelen worden meegeleverd voor u dit product gebruikt. Aarzel niet om contact op te nemen met uw lokale EMS leverancier voor meer informatie.





ACERCA DESTE MANUAL

Estas instruções de utilização destinam-se a assegurar a correcta instalação e utilização deste produto.

Leia atentamente estas instruções de utilização, nas quais se explicam todos os pormenores e procedimentos mais importantes. Preste especial atenção às precauções de segurança.

Mantenha este documento sempre à mão.

Para evitar lesões em pessoas e danos materiais, preste especial atenção às observações e avisos relevantes. Estes encontram-se assinalados como se segue:



Perigo

Risco de lesão para o doente ou utilizador



Atenção

Risco de danos no dispositivo ou danos ambientais



Nota

Informações e sugestões adicionais úteis



Proibido



Autorizado



As instruções relativas aos componentes do sistema são apresentadas em separado das instruções de utilização. Leia os manuais de instruções que acompanham cada um dos componentes antes de utilizar este produto. Não hesite em contactar o seu revendedor EMS para obter mais informações.

OM DENNE VEJLEDNING

Disse betjeningsinstruktioner skal sikre korrekt installation og brug af dette produkt.

Læs disse betjeningsinstruktioner omhyggeligt, da de forklarer alle de vigtigste oplysninger og procedurer. Vær særlig opmærksom på de sikkerhedsmæssige forholdsregler.

Sørg for, at dette dokument altid er ved hånden.

Vær opmærksom på de tilsvarende direktiver for at undgå skader på mennesker og ejendom. De har følgende mærkninger:



Fare

Risiko for skader på patient eller bruger



Forsigtig

Risiko for skader på anordning eller miljø



Bemærk

Yderligere nyttige oplysninger og råd



Forbudt



Tilladt



Instruktioner vedrørende systemets komponenter gives separat i den pågældende brugsanvisning. Læs brugervejledningen, der leveres sammen med hver af komponenterne, før dette produkt tages i brug. Kontakt endelig din lokale EMS-forhandler for at få yderligere information.

OM DENNE HÅNDBOKEN

Målet med denne bruksanvisningen er å sikre riktig installering og bruk av dette produktet.

Les bruksanvisningen nøye – den inneholder en beskrivelse av alle de viktigste detaljene og prosedyrene. Vær spesielt oppmerksom på sikkerhetsforholdsreglene.

Bruksanvisningen må alltid være lett tilgjengelig.

For å hindre skade på personer og eiendom må de aktuelle retningslinjene følges. De er merket som følger:



Fare

Fare for skade på pasienten eller brukeren



OBS!

Fare for skade på produktet eller miljøet



Merk

Nyttig tilleggsinformasjon og nyttige tips



Forbudt



Tillatt



Instruksjoner som gjelder delene i systemet, gis separat i de tilhørende bruksanvisningene. Les bruksanvisningene som følger med hver av delene, før dette produktet tas i bruk. Ta gjerne kontakt med den lokale EMS-forhandleren hvis du trenger mer informasjon.





Note that the English version of this manual is the master from which translations derive. In case of any discrepancy, the binding version is the English text.

We would be pleased to answer your questions or listen to your suggestions. We do, of course, provide support in case of technical problems. Please call your approved EMS repair center or dealer directly.

We wish you lots of success!

EMS

Napominjemo da je priručnik izvorno napisan na engleskom, na temelju kojeg su izrađeni svi prijevodi. U slučaju nepodudaranja važeći je tekst na engleskom.

Rado ćemo vam odgovoriti na pitanja ili razmotriti vaše prijedloge. Nudimo, naravno, i podršku u slučaju tehničkih problema. Nazovite izravno ovlaštenu centar za popravku tvrtke EMS ili svojeg zastupnika.

Želimo vam puno uspjeha!

EMS

Merk op dat de Engelse versie van deze handleiding de bron is waarvan de vertalingen zijn afgeleid. In geval van een afwijking, is de Engelse tekst de bindende versie.

We zijn graag bereid uw vragen te beantwoorden of naar uw suggesties te luisteren. Uiteraard bieden we ondersteuning in geval van technische problemen. Bel in dat geval rechtstreeks uw erkende EMS-reparatiecentrum of uw leverancier.

Veel succes!

EMS

Technical modifications

EMS reserves the right to modify the technique, accessories, operating instructions or contents of the set due to technical or scientific improvements.

Tehničke izmjene

EMS zadržava pravo izmijeniti tehniku, dodatke, upute za rukovanje ili sadržaj paketa radi tehničkih ili znanstvenih poboljšanja.

Technische aanpassingen

EMS behoudt zich het recht voor de techniek, toebehoren, gebruiksaanwijzing of inhoud van de set te wijzigen in verband met technische of wetenschappelijke verbeteringen.





A versão inglesa deste manual é a versão original do mesmo, a partir da qual foram efectuadas as diferentes traduções. Em caso de discrepâncias, a versão prevalecente é a inglesa.

Estamos à sua inteira disposição para responder a todas as perguntas ou dúvidas que possa ter e para ouvir as suas sugestões. Além disso, oferecemos naturalmente assistência em caso de problemas técnicos. É favor ligar directamente para o seu centro de reparação aprovado pela EMS ou para o seu revendedor.

Os nossos votos de muito sucesso!

EMS

Bemærk, at den engelske version af denne vejledning er den original, der oversættes fra. I tilfælde af eventuelle uoverensstemmelser er den engelske tekst den bindende version.

Vi vil med fornøjelse besvare dine spørgsmål eller lytte til dine forslag. Vi yder selvfølgelig støtte i tilfælde af tekniske problemer. Ring direkte til dit godkendte EMS-reparationscenter eller din forhandler.

Vi ønsker dig held og lykke!

EMS

Den engelske versjonen av denne håndboken er originalen som andre språk er oversatt fra. Ved eventuelle uoverensstemmelser er det den engelske teksten som gjelder.

Vi svarer gjerne på spørsmål eller mottar forslag fra deg. Vi gir selvfølgelig support ved tekniske problemer. Ring enten direkte til EMS' godkjente reparasjonssenter eller forhandleren.

Lykke til!

EMS

Modificações técnicas

A EMS reserva-se o direito de modificar a componente técnica, os acessórios, as instruções de utilização ou o conteúdo do conjunto devido à introdução de aperfeiçoamentos técnicos ou científicos.

Tekniske modifikationer

EMS forbeholder sig ret til at ændre teknik, tilbehør, betjeningsinstruktioner eller indhold i sættet på grund af tekniske eller videnskabelige forbedringer.

Tekniske endringer

EMS forbeholder seg retten til å endre teknikken, tilbehøret, bruksanvisningene eller innholdet i settet på grunn av tekniske eller vitenskapelige forbedringer.





CONTENTS

General hints	2
Bacteria reduction in the spray	4
Attaching the instruments	6
File holders	8
Positioning files or instruments	10
Working technique	14
Diamond-coated instruments	16
Scaling	18
Instrument A for universal scaling	21
Instrument B for lingual scaling	23
Instrument perio P	25
Instrument perio slim PS	27
Instruments PSR and PSL	29
Specific instrument PI for implants cleaning	31
Endo	32
Files for the orthograde therapy	32
Endodontic retreatment	34
Retrograde endodontics	36
K-type cleaning files (ISO 15 - 35)	39
Endo soft instrument ESI (ISO 15)	41
Retreatment instrument RT1	43
Retreatment instrument RT2	45
Retreatment instrument RT3	47
Condensation instrument H	49
Removal instrument D	51
Retrograde instrument Berutti	53
Retrograde instrument for isthmus RE2	55
Restorative	56
Cavity preparation	56
Amalgams and cementation	58
Cavity instruments SD and SM	61
Small ball instrument SB	63
Small ball instruments SBd and SBm	65

SADRŽAJ

Opći savjeti	2
Smanjenje količine bakterija u raspršivaču	4
Spajanje instrumenata	6
Držači za igle	8
Postavljanje igala ili instrumenata	10
Radna tehnika	14
Dijamantno presvučeni instrumenti	16
Uklanjanje zubnog kamenca	18
Instrument A za univerzalno uklanjanje kamenca	21
Instrument B za uklanjanje lingvalnog kamenca	23
Instrument perio P	25
Instrument perio slim PS	27
Instrumenti PSR i PSL	29
Posebni instrument PI za čišćenje implantata	31
Endodonticja	32
Igle za ortogradnu terapiju	32
Ponovni endodontski tretman	34
Retrogradna endodonticja	36
Igle za čišćenje K tipa (ISO 15 - 35)	39
Endodontski mekani ESI instrument (ISO 15)	41
Instrument za ponovni tretman RT1	43
Instrument za ponovni tretman RT2	45
Instrument za ponovni tretman RT3	47
Kondenzacijski instrument H	49
Instrument za uklanjanje D	51
Retrogradni instrument Berutti	53
Retrogradni instrument za suženja RE2	55
Restauracija	56
Priprema šupljine	56
Amalgami i cementiranje	58

INHOUDSOPGAVE

Algemene tips	2
Vermindering aantal bacteriën in de spray	4
Bevestiging van de instrumenten	6
Vijlhouders	8
Positionering van vijlen of instrumenten	10
Behandeltechniek	14
Diamantinstrumenten	16
Scaling	18
Instrument A voor universele scaling	21
Instrument B voor linguale scaling	23
Instrument perio P	25
Instrument perio dun PS	27
Instrumenten PSR en PSL	29
Specifiek instrument PI voor reiniging van implantaten	31
Endo	32
Vijlen voor orthograde behandeling	32
Endodontische herbehandeling	34
Retrograde endodontie	36
K-vijlen voor reiniging (ISO nr. 15 - 35)	39
Endo soft ESI instrument (ISO nr. 15)	41
Instrument RT1 voor herbehandeling	43
Instrument RT2 voor herbehandeling	45
Instrument RT3 voor herbehandeling	47
Condensatie-instrument H	49
Verwijderingsinstrument D	51
Retrograad instrument Berutti	53
Retrograad instrument voor isthmus RE2	55
Restauratie	56
Preparatie caviteit	56
Amalgamen en cementering	58
Instrumenten SD en SM voor caviteiten	61
Klein knopvormig instrument SB	63



ÍNDICE

Sugestões gerais.....	3
Redução das bactérias na pulverização.....	5
Fixação dos instrumentos.....	7
Porta-limas.....	9
Posicionamento das limas ou instrumentos.....	11
Técnica de trabalho.....	15
Instrumentos diamantados.....	17
Destartarização.....	19
Instrumento A para destartarização universal.....	21
Instrumento B para destartarização lingual.....	23
Instrumento perio P.....	25
Instrumento perio slim PS.....	27
Instrumentos PSR e PSL.....	29
Instrumento específico PI para limpeza de implantes.....	31
Endodontia.....	33
Limas para terapia ortógrada.....	33
Retratamento endodôntico.....	35
Endodontia retrógrada.....	37
Limas de limpeza do tipo K (ISO 15 - 35).....	39
Instrumento endo soft ESI (ISO 15).....	41
Instrumento de retratamento RT1.....	43
Instrumento de retratamento RT2.....	45
Instrumento de retratamento RT3.....	47
Instrumento de condensação H.....	49
Instrumento de remoção D.....	51
Instrumento retrógrado Berutti.....	53
Instrumento retrógrado para istmo RE2.....	55
Reconstrução.....	57
Preparação de cavidades.....	57
Amálgamas e cimentação.....	59
Instrumentos para cavidades SD e SM.....	61

INDHOLD

Generelle råd.....	3
Bakteriereduktion i strålen.....	5
Fastgøring af instrumenterne.....	7
Filholdere.....	9
Montering af filer eller instrumenter.....	11
Arbejdsteknik.....	15
Diamantbelagte instrumenter.....	17
Tandrensning.....	19
Instrument A til universel tandrensning.....	21
Instrument B til lingualtandrensning.....	23
Instrument perio P.....	25
Instrument perio tynd PS.....	27
Instrumenterne PSR og PSL.....	29
Specialinstrument PI til rensning af implantater.....	31
Endodonti.....	33
Filer til ortograd behandling.....	33
Endodontisk genbehandling.....	35
Retrograd endodonti.....	37
K-rensningsfiler (ISO/15 - 35).....	39
Blødt endoinstrument ESI (ISO/15).....	41
Genbehandlingsinstrument RT1.....	43
Genbehandlingsinstrument RT2.....	45
Genbehandlingsinstrument RT3.....	47
Kondenseringsinstrument H.....	49
Udtagningsinstrument D.....	51
Retrogradt Berutti-instrument.....	53
Retrogradt instrument til isthmus RE2.....	55
Restorativ behandling.....	57
Præparation af kavitet.....	57
Amalgamer og cementering.....	59
Kavitetsinstrumenterne SD og SM.....	61
Lille kugleinstrument SB.....	63
De små kugleinstrumenter SBd og SBm.....	65

INNHold

Generelle tips.....	3
Reduksjon av bakterier i strålen.....	5
Feste instrumentene.....	7
Filholdere.....	9
Plassere filer eller instrumenter.....	11
Arbeidsteknikk.....	15
Diamantbelagte instrumenter.....	17
Scaling.....	19
Instrument A til universell scaling.....	21
Instrument B til lingual scaling.....	23
Perio-instrument P.....	25
Tynt perio-instrument PS.....	27
Instrumenter PSR and PSL.....	29
Spesialinstrument PI til rengjøring av implantater.....	31
Endodonti.....	33
Filer til ortograd behandling.....	33
Endodontisk revisjonsbehandling.....	35
Retrograd endodonti.....	37
K-filer til rengjøring (ISO 15 - 35).....	39
Mykt endoinstrument ESI (ISO 15).....	41
Revisjonsinstrument RT1.....	43
Revisjonsinstrument RT2.....	45
Revisjonsinstrument RT3.....	47
Kondenseringsinstrument H.....	49
Fjerningsinstrument D.....	51
Retrograd instrument Berutti.....	53
Retrograd instrument til isthmus RE2.....	55
Restorativ behandling.....	57
Preparering av kaviteter.....	57
Amalgam og sementering.....	59
Kavitetsinstrument SD og SM.....	61
Lilleinstrument SB.....	63
Kuleinstrument SBd og SBm.....	65



Instrument for pits and fissures PF.....	67	Instrumenti za šupljine SD i SM.....	61	Kleine knopvormige instrumenten SBd en SBm	65
Instrument for veneers VE.....	69	Instrument s malom kuglom SB.....	63	Instrument voor putten en fissuren PF	67
Cementation instrument SP.....	71	Instrumenti SBd i SBm s malom kuglom	65	Instrument voor veneers VE.....	69
Periodontics.....	72	Instrument za udubine i fisure PF.....	67	Instrument voor cementering SP.....	71
perio line.....	74	Instrument za glazure VE.....	69	Parodontie	72
Working with curved instruments.....	75	Instrument za cementiranje SP.....	71	Werken met gebogen instrumenten	75
Perio line instruments PL1 and PL2	77	Parodontologija.....	72	Perio-lijn instrumenten PL1 en PL2.....	77
Perio line instrument PL3.....	79	Rad sa zakrivljenim instrumentima	75	Perio-lijn instrument PL3	79
Perio line instruments PL4 and PL5	81	Parodontalni linijski Instrumenti PL1 i PL2 .	77	Perio-lijn instrument PL4 en PL5.....	81
Instruments perio HPL3 and DPL3	83	Parodontalni linijski instrumenti PL3	79	Instrumenten perio HPL3 en DPL3.....	83
Cleaning, disinfecting and sterilizing	84	Parodontalni linijski instrumenti PL4 i PL5..	81	Reinigen, desinfecteren en steriliseren	84
Instrument disassembly and cleaning	86	Parodontalni instrumenti HPL3 i DPL3	83	Demontage en reiniging instrument.....	86
Handpiece disassembly and cleaning	88	Čišćenje, dezinfekcija	84	Demontage en reiniging handstuk.....	88
File holder disassembly and cleaning.....	90	i sterilizacija	84	Demontage en reiniging vijlhouder	90
Wear and maintenance	92	Rastavljanje i čišćenje instrumenta.....	86	Slijtage en onderhoud.....	92
Safety precautions.....	94	Rastavljanje i čišćenje nasadnika.....	88	Voorzorgsmaatregelen voor de veiligheid ..	94
Storing the product	98	Rastavljanje i čišćenje držača za igle	90	Opbergen van het product.....	98
Product disposal.....	100	Kontrola i održavanje.....	92	Afvoeren van het product.....	100
Warranty	100	Mjere opreza.....	94	Garantie	100
Accessories	100	Skladištenje proizvoda.....	98	Toebehoren.....	100
EMS customer service.....	102	Odlaganje proizvoda na otpad.....	100	EMS-klantenservice.....	102
Symbols.....	104	Jamstvo	100	Symbolen.....	104
Technical data.....	105	Dodaci	100	Technische gegevens	106
Troubleshooting.....	108	Odjel za korisnike tvrtke EMS.....	102	Probleemoplossing	110
		Simboli.....	104		
		Tehnički podaci	105		
		Otklanjanje poteškoća	109		



Instrumento com pequena ponta esférica SB	63	Instrument til huller og fissurer PF	67	Instrument for hull og fissurer PF.....	67
Instrumentos com pequena ponta esférica SBd e SBm	65	Instrument til veneers VE.....	69	Instrument for fasader VE.....	69
Instrumento para fossas e fissuras PF	67	Cementeringsinstrument SP.....	71	Sementeringsinstrument SP	71
Instrumento para vernizes VE	69	Parodonti	73	Periodonti	73
Instrumento de cimentação SP.....	71	Sådan arbejdes med buede instrumenter ..	75	Arbejde med bøjede instrumenter	75
Periodontia	73	Paroinstrumenterne PL1 og PL2	77	Perio-instrument PL1 og PL2.....	77
Trabalhar com instrumentos curvos	75	Paroinstrument PL3.....	79	Perio-instrument PL3.....	79
Instrumentos Perio line PL1 e PL2	77	Paroinstrumenterne PL4 og PL5	81	Perio-instrument PL4 og PL5.....	81
Instrumento Perio line PL3	79	Paroinstrumenterne HPL3 og DPL3	83	Perio-instrument HPL3 og DPL3	83
Instrumentos Perio line PL4 e PL5	81	Rengøring, desinficering og sterilisering	85	Rengjøring, desinfisering og sterilisering.....	85
Instrumentos Perio HPL3 e DPL3.....	83	Demontering og rengøring af instrumenter ..	87	Demontering og rengjøring av instrumenter	87
Limpeza, desinfecção e esterilização.....	85	Demontering og rengøring af håndstykket ..	89	Demontering og rengjøring av håndstykker	89
Desmontagem e limpeza dos instrumentos	87	Demontering og rengøring af filholder	91	Demontering og rengjøring av filholdere	91
Desmontagem e limpeza da peça de mão ..	89	Slitasje og vedlikeholdelse	93	Slitasje og vedlikehold	93
Desmontagem e limpeza do porta-limas	91	Opbevaring af produktet	99	Oppbevaring av produktet	99
Desgaste e manutenção.....	93	Bortskaffelse af produkt.....	101	Kassering av produktet.....	101
Precauções de segurança.....	95	Garanti.....	101	Garanti.....	101
Armazenamento do produto	99	Tilbehør	101	Tilbehør	101
Eliminação do produto.....	101	EMS-kundeservice	103	EMS' kundetjeneste.....	103
Garantia.....	101	Symboler	104	Symboler	104
Acessórios	101	Tekniske data.....	107	Tekniske data.....	107
Apoio ao cliente da EMS	103	Fejlfinding	112	Feilsøking	113
Símbolos.....	104				
Dados técnicos.....	106				
Resolução de problemas.....	111				







GENERAL HINTS

OPĆI SAVJETI

ALGEMENE TIPS

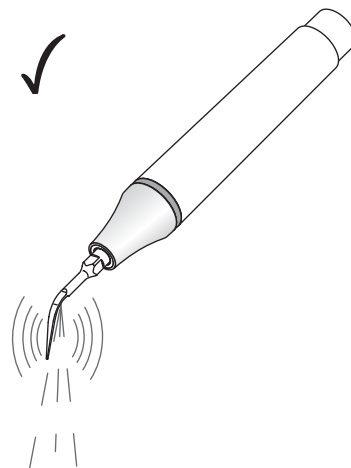
135°C
SSS





 Make sure to always sterilize handpieces and instruments before use. Non-sterile handpieces and instruments may cause bacterial or viral infections. Please conform to the recommendations of the "Reprocessing Instructions" manual delivered with your product regarding procedure of cleaning, disinfecting and sterilizing of the components.

 Never work dry with Piezon instruments (unless otherwise specified). The tip of the instrument immediately heats up when used dry. Always make sure there is enough irrigation.

 Do not use the instruments on metal or ceramic restorations, neither on prosthesis units as they might be damaged (unless otherwise specified).

 Prije uporabe uvijek treba sterilizirati nasadnike i instrumente. Nesterilni dijelovi i dodaci mogu prouzročiti bakterijske ili virusne infekcije. Molimo pridržavajte se uputa u svezi s čišćenjem, dezinfekcijom i sterilizacijom komponenata u priručniku "Upute za reprocesiranje" isporučenom s vašim proizvodom.

 Nikad ne radite na suho s Piezon instrumentima (osim ako nije drugačije navedeno). Vrh instrumenta odmah se zagrijava kada se koristi na suho. Uvijek osigurajte dovoljno ispiranja.

 Nemojte koristiti instrumente na metalnim ili keramičkim restraucijama, niti na jedinicama proteze budući da bi se mogli oštetiti (osim ako nije drugačije navedeno).

 Zorg dat u handstukken en instrumenten altijd voor gebruik steriliseert. Niet-steriele handstukken en instrumenten kunnen bacteriële of virale infecties veroorzaken. Houd u aan de aanbevelingen van de handleiding 'Instructies voor verwerking' die met uw product is meegeleverd voor de procedure voor reiniging, desinfectie en sterilisatie van de onderdelen.

 Gebruik Piezon-instrumenten nooit droog (tenzij anders aangegeven). De tip van het instrument wordt onmiddellijk warm bij droog gebruik. Zorg altijd voor voldoende irrigatie.

 Gebruik de instrumenten niet op metalen of keramische restauraties, en niet op protheseonderdelen aangezien ze dan beschadigd kunnen raken (tenzij anders aangegeven).







SUGESTÕES GERAIS

GENERELLE RÅD

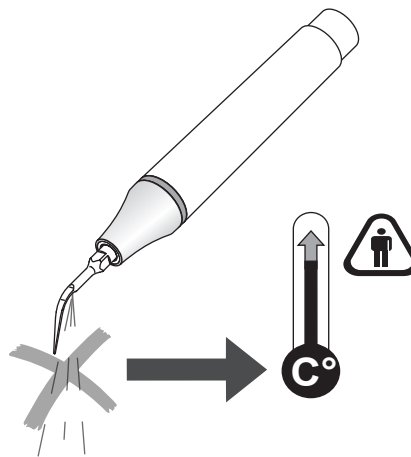
GENERELLE TIPS





 Assegure-se de que esteriliza sempre as peças de mão e os instrumentos antes de utilizar. As peças de mão e os instrumentos não esterilizados podem causar infecções virais ou bacterianas. Relativamente à limpeza, desinfecção e esterilização dos componentes, deve respeitar todas as recomendações do manual de "Instruções de reprocessamento" que acompanha o produto.

 Nunca utilize os instrumentos Piezon sem irrigação (excepto em caso de especificação em contrário). A ponta do instrumento aquece imediatamente quando é usada a seco. Assegure-se sempre de que existe irrigação suficiente.

 Não utilize os instrumentos em reconstruções metálicas ou cerâmicas nem em próteses para não as danificar (excepto em caso de especificação em contrário).

 Sørg for altid at sterilisere håndstykkerne og instrumenterne før brug. Usterile håndstykker og instrumenter kan forårsage bakterie- eller virusinfektioner. Følg anbefalingerne i vejledningen "Instruktioner i genbehandling", der blev leveret sammen med dit produkt, vedrørende rengøring, desinficering og sterilisering af komponenterne.

 Undlad at arbejde tørt med Piezon-instrumenterne (medmindre andet er angivet). Instrumentspidsen ophedes omgående, når den anvendes i tør tilstand. Sørg altid for, at skylningen er tilstrækkelig.

 Anvend ikke instrumenterne på metal eller keramiske konstruktioner, ej heller på proteser, da de kan blive beskadiget (medmindre andet er angivet).

 Håndstykkene og instrumentene må altid steriliseres før brug. Ikke-sterile håndstykker og instrumenter kan forårsage bakterie- eller virusinfeksjoner. Følg anbefalingene om rengjøring, desinfisering og sterilisering av delene i håndboken "Instruksjoner for behandling etter bruk".

 Du må aldri arbeide "tørt" med Piezon-instrumenter (med mindre annet er angitt). Spissen på instrumentet blir umiddelbart varm når den brukes "tørt". Sørg for at det alltid er tilstrekkelig irrigasjon.

 Instrumentene må ikke brukes på rekonstruksjoner av metall eller keramikk eller på proteser, det kan føre til at de blir skadet (med mindre annet er angitt).







Bacteria reduction in the spray

Smanjenje količine bakterija u raspršivaču

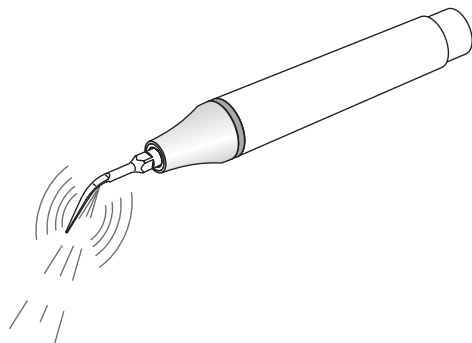
Vermindering aantal bacteriën in de spray



Oscillating or rotating dental instruments produce a spray of irrigation. The bacterial count in the spray can be truly reduced by using the ready-for-use BacterX[®] pro* solution (0.2% chlorhexidine) in the EMS Piezon unit.

 Rinsing the patient's mouth prior to treatment with BacterX[®] pro* is strongly recommended.

Used daily in your EMS Piezon unit, BacterX[®] pro* reduces the bacterial count in the irrigation lines of the unit.

* BacterX[®] pro is available in specific countries only

Oscilirajući ili rotirajući stomatološki instrumenti uzrokuju raspršivanje kod ispiranja. Razina bakterija može se značajno smanjiti uporabom BacterX[®] pro* otopine (0,2% klorheksidin) u EMS Piezon jedinici.

 Preporučuje se ispiranje usta pacijenta pomoću BacterX[®] pro* prije tretmana.

Ako se svakodnevno koristi u EMS Piezon jedinici, BacterX[®] pro* smanjuje razinu bakterija u linijama za ispiranje jedinice.

* BacterX[®] raspoloživ je samo u nekim zemljama

Trillende of roterende tandheelkundige instrumenten veroorzaken een spray van irrigatie. Het aantal bacteriën in de nevel kan echt worden verminderd door gebruik van kant-en-klare BacterX[®] pro*-oplossing (0,2% chloorhexidine) in het EMS Piezon-apparaat.

 Het spoelen van de mond van de patiënt met BacterX[®] vóór de behandeling wordt sterk aanbevolen.

Bij dagelijks gebruik in uw EMS Piezon-apparaat vermindert BacterX[®] het aantal bacteriën in de irrigatielijnen van het apparaat.

* BacterX[®] pro is slechts in een aantal landen verkrijgbaar





Redução das bactérias na pulverização

Bakteriereduktion i strålen

Reduksjon av bakterier i strålen



Os instrumentos dentários oscilantes ou rotativos produzem uma pulverização de irrigação. A contagem de bactérias na pulverização pode efectivamente ser reduzida pela utilização da solução BacterX® pro* pronta a usar (clorexidina a 0,2%) na unidade EMS Piezon.

 Recomenda-se vivamente o enxaguamento da boca do paciente com BacterX® pro* antes do tratamento.

Usado diariamente na unidade EMS Piezon, o BacterX® pro* reduz a contagem bacteriana nas linhas de irrigação da unidade.

* A solução BacterX® pro apenas está disponível em determinados países.

Oscillerende eller roterende dentalinstrumenter producerer en stråleskyllning. Bakteriemængden i strålen kan reduceres mærkbart ved at anvende den brugsklare opløsning BacterX® pro* (0,2 % chlorhexidin) i EMS Piezon-enheden.

 Det anbefales kraftigt at skylle patientens mund før behandlingen med BacterX® pro*.

Ved daglig brug i EMS Piezon-enheden reducerer BacterX® pro* bakteriemængden i enhedens skylleslanger.

* BacterX® pro kan kun fås i specifikke lande

Oscillerende eller roterende dentale instrumenter producerer væskesprut. Bakteriemængden i strålen kan mindkes betragtelig ved å bruke den bruksklare løsningen BacterX® pro* (0,2 % klorheksidin) i EMS Piezon-enheten.

 Det anbefales på det sterkeste at pasienten skyller munnen med BacterX® pro* før behandlingen.

Hvis BacterX® pro* brukes daglig i EMS Piezon-enheten, reduseres bakteriemengden i enhetens irrigasjonsslanger.

* BacterX® pro er kun tilgjengelig i enkelte land





ATTACHING THE INSTRUMENTS

SPAJANJE INSTRUMENATA

BEVESTIGING VAN DE INSTRUMENTEN

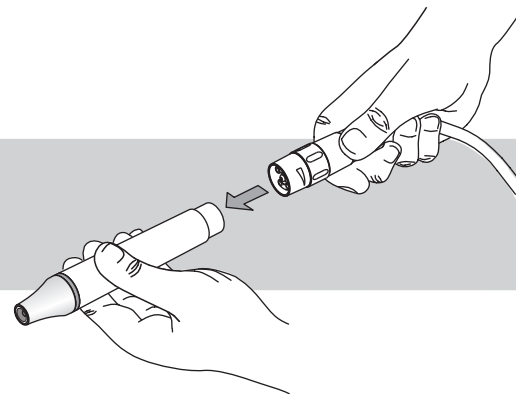
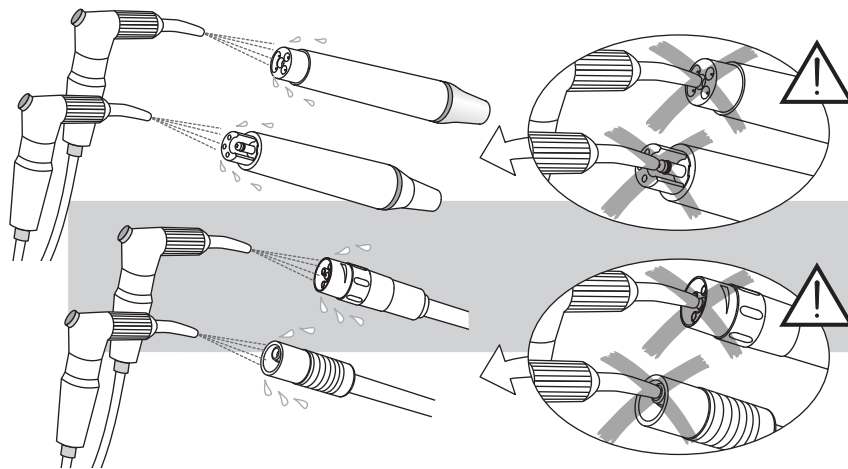

! Blow dry the connections to remove eventual presence of liquid to ensure a proper electrical contact. Never blow compressed air in the irrigation connections as this will irretrievably damage internal parts.

! Only use the CombiTorque to tighten the EMS instrument on the handpiece to the correct torque. Once the instrument is screwed all the way in, give an extra quarter of a turn to obtain the required torque.

! The EMS CombiTorque combines a torque wrench and an individual file holder. It ensures an installation according to specifications, an organized storage and a safeguard against injuries or contamination.

! Puhanjem osušite priključke kako biste uklonili moguće ostatke tekućine i osigurali pravilan električni kontakt. Nikad ne upuhujte komprimirani zrak u priključke za ispiranje jer će to nepovratno oštetiti unutarnje dijelove.

! Koristite samo kombinirani ključ (CombiTorque) da biste pritegnuli instrument EMS na nasadnik ispravnim okretnim momentom. Nakon što je instrument pričvršćen vijcima do kraja, okrenite ih za još četvrtinu okretaja kako biste postigli potreban zakretni moment.

! EMS CombiTorque kombinira zakretni ključ i držač pojedinačnih igala. On osigurava instalaciju u skladu sa specifikacijama i organizirano skladištenje i sigurnost od ozljeda ili kontaminacije.

! Blaas de aansluitingen droog om een goed elektrisch contact te garanderen. Blaas nooit perslucht in de irrigatieaansluitingen aangezien dit inwendige delen onherstelbaar zal beschadigen.

! Gebruik uitsluitend de CombiTorque om het EMS-instrument met het juiste draaimoment op het handstuk te bevestigen. Draai zodra het instrument volledig is vastgedraaid een extra kwartslag om het noodzakelijke draaimoment te verkrijgen.

! De CombiTorque van EMS is een combinatie van een momentsleutel en een afzonderlijke vijlhouder. De CombiTorque zorgt voor installatie conform de specificaties, een systematische manier van bewaren en bescherming tegen letsels of verontreiniging.



FIXAÇÃO DOS INSTRUMENTOS

FASTGØRING AF INSTRUMENTERNE

FESTE INSTRUMENTENE

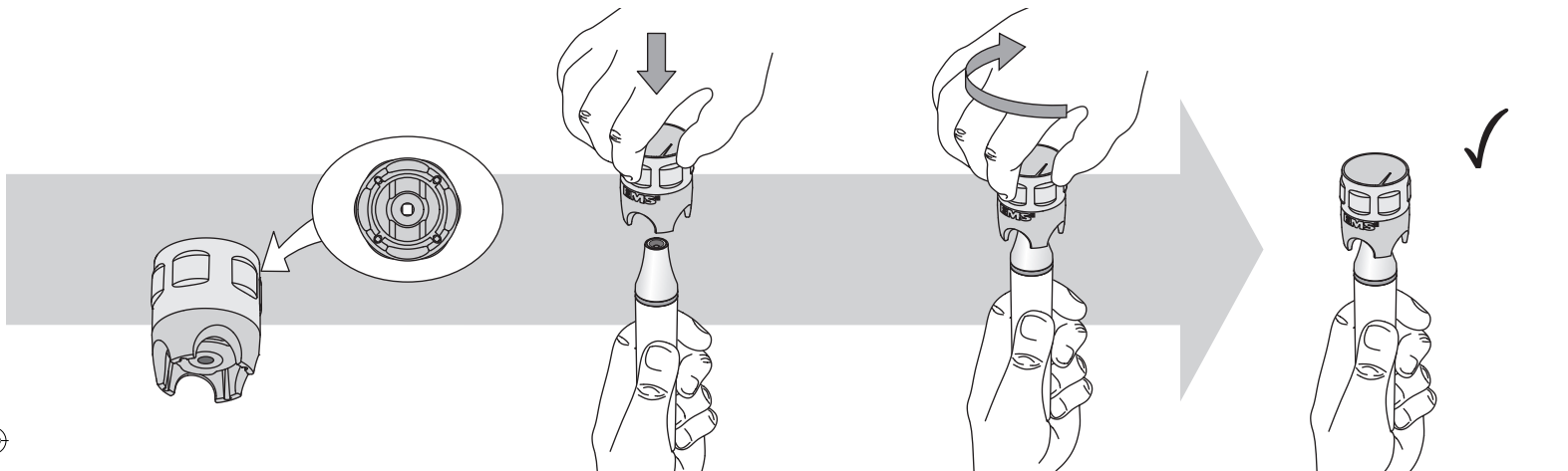

⚠ Seque as ligações com ar para remover eventuais restos de líquido e assegurar um bom contacto eléctrico. Nunca utilize um jacto de ar comprimido nas ligações de irrigação para não danificar as peças internas de forma irreparável.

⚠ Utilize apenas o CombiTorque para apertar o instrumento EMS na peça de mão, até ao binário de aperto correcto. Depois de apertar completamente o instrumento, aplique mais um quarto de volta para conseguir o binário de aperto mais adequado.

👉 O EMS CombiTorque combina uma chave dinamométrica e um porta-limas individual. Assegura uma instalação de acordo com as especificações, um armazenamento organizado e constitui uma salvaguarda contra lesões ou contaminação.

⚠ Tørblæs tilslutningerne for at fjerne eventuel forekomst af væske, så der sikres en korrekt elektrisk kontakt. Blæs aldrig komprimeret luft ind i skylletilslutningerne, da dette vil gøre uoprettelig skade på de indvendige dele.

⚠ Anvend kun CombiTorque til at stramme EMS-instrumentet på håndstykket til det korrekte drejningsmoment. Drej en ekstra kvart omgang for at opnå det påkrævede drejningsmoment, når instrumentet er skruet helt ind.

👉 EMS CombiTorque kombinerer en momentnøgle og en individuel filholder. Instrumentet sikrer, at en installation er i overensstemmelse med specifikationerne, en organiseret opbevaring og en sikkerhedsforanstaltning mod kvæstelser eller kontamination.

⚠ Blås koblingsstykkene tørre for å fjerne eventuell væske og sikre riktig elektrisk kontakt. Blås aldri trykkluft inn i irrigasjonskoblingene, dette vil skade de indre delene permanent.

⚠ Bruk kun CombiTorque til å stramme EMS-instrumentet på håndstykket til riktig dreiemoment. Når instrumentet er skrudd helt inn, skrur du til en ekstra kvart omdreining for å oppnå nødvendig dreiemoment.

👉 EMS CombiTorque består av en momentnøkkel og en individuell filholder. Verktøyet sikrer at monteringen skjer i henhold til spesifikasjonene, samtidig som det er et trygt oppbevaringssted som beskytter mot skader eller kontaminering.



File holders

Držači za igle

Vijlhouders

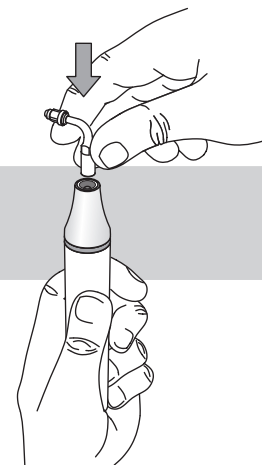
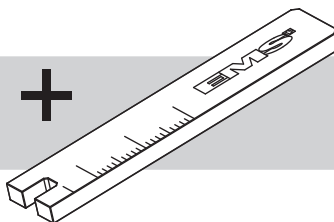
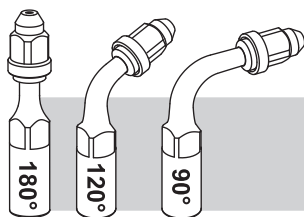

The file holders are available in 90°, 120° or 180° (straight) orientations to adapt to particular configurations.

! Use only the provided flat wrench to tighten the file holders on the handpiece, as well as for gently tightening the instruments or files in the chuck. Do not overtighten.

! Do not tighten the chuck nut when no file or instrument is installed as this may damage it.

Držači za igle raspoloživi su u 90°, 120° ili 180° (ravno) orijentacijama kako bi se prilagodili posebnostima konfiguracije.

! Koristite samo isporučeni ravni ključ kako biste pričvrstili držače za igle na nasadnik kao i za lagano pričvršćivanje instrumenata i igli u držači. Nemojte previše stegnuti.

! Nemojte stegnuti nazubljenu maticu kad nema postavljenog držača ili instrumenta jer je na taj način možete oštetiti.

De vijlhouders zijn verkrijgbaar in een hoek van 90°, 120° of 180° (recht) voor speciale configuraties.

! Gebruik uitsluitend de meegeleverde platte sleutel om de vijlhouders op het handstuk te bevestigen, evenals om de instrumenten of vijlen voorzichtig in de boorhouder te klemmen. Niet te strak aandraaien.

! Draai de moer van de boorhouder alleen aan wanneer er een vijl of ander instrument is geplaatst, omdat er anders schade kan optreden.





Porta-limas

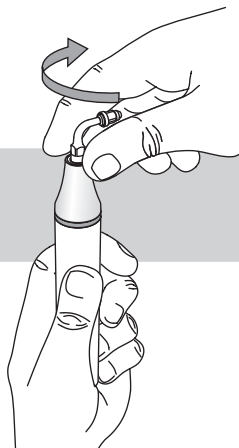

Filholdere

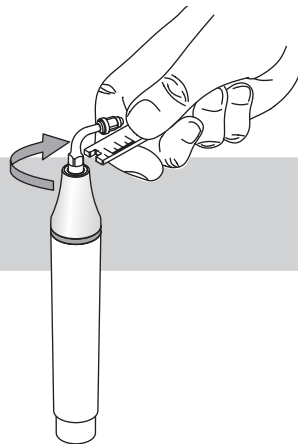

Filholdere



Os porta-limas estão disponíveis em orientações de 90°, 120° ou 180° (rectos) para se adaptarem a determinadas configurações.

⚠ Utilize apenas a chave de fendas fornecida para apertar os porta-limas à peça de mão e para apertar cuidadosamente os instrumentos ou limas no mandril. Não aperte em excesso.

⚠ Não aperte a porca do mandril quando não existir uma lima ou instrumento instalado, para não causar danos no mandril.

Filholderne leveres i vinkler på 90°, 120° eller 180° (lige) for at passe til bestemte konfigurationer.

⚠ Anvend kun den medfølgende flade skrue-nøgle til at stramme filholderne på håndstykket, lige så vel som til forsigtigt at stramme instrumenterne eller filerne i chuck'en. Undlad at overstramme.

⚠ Stram ikke chuck-møtrikken, når der ikke er installeret en fil eller et instrument, da dette kan beskadige den.

Filholderne fås med vinkler på 90°, 120° eller 180° (rett) som gjør at de passer til ulike konfigurasjoner.

⚠ Bruk kun den medfølgende flate nøkkelen til å stramme til filholderne på håndstykket samt for å stramme instrumentene eller filene i chucken forsiktig. Du må ikke stramme for mye.

⚠ Chuckmutteren må ikke strammes hvis ingen fil eller instrument er installert, det kan skade den.





Positioning files or instruments

Postavljanje igala ili instrumenata

Positionering van vijlen of instrumenten

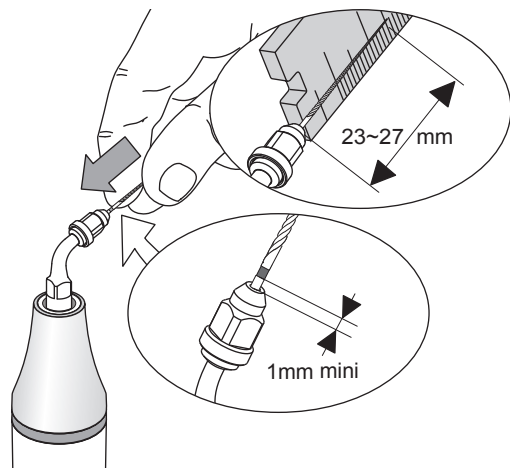

K-type files

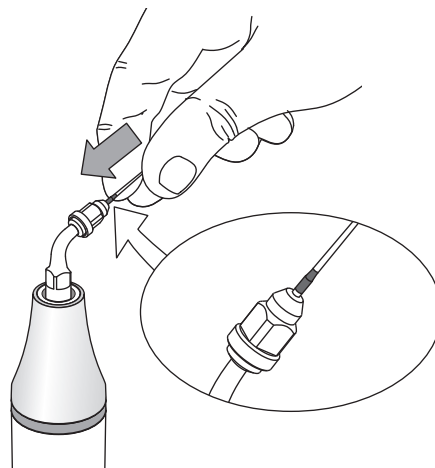

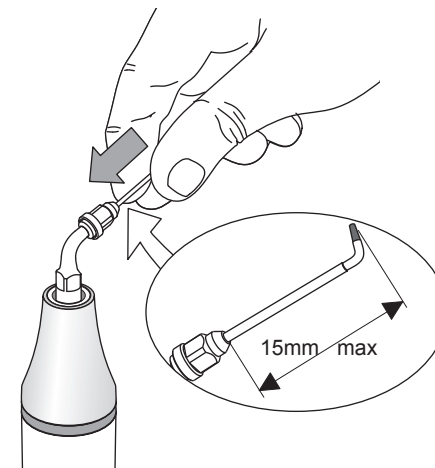

ESI file





Berutti & RE2 instruments

 The markings on the files are indicators of the insertion level in the file holder.

 Listen to noise change when the file is activated to detect a possible untightening of file or instrument in file holder.

 Oznake na iglama ukazuju na razinu umetanja u držač za igle.

 Slušajte promjenu u zvuku kad je igla aktivirana kako biste otkrili moguće otpuštanje igle ili instrumenta u držaču za igle.

 De markeringen op de vijlen geven aan tot hoever ze in de vijlhouder moeten worden ingebracht.

 Wees bij een geactiveerde vijl alert op een verandering in geluid aangezien dit kan betekenen dat een vijl of instrument is komen los te zitten in de vijlhouder.





Posicionamento das limas ou instrumentos

Montering af filer eller instrumenter

Plassere filer eller instrumenter

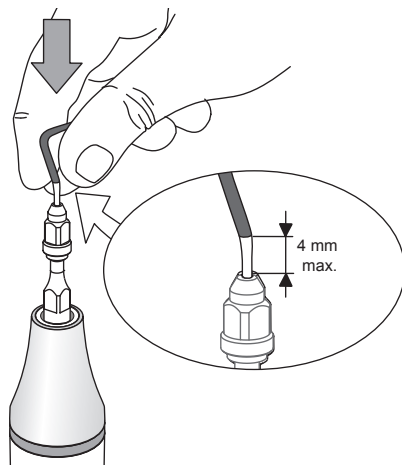

RT3 instrument

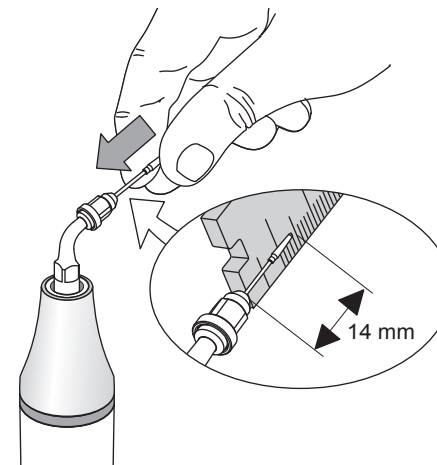



PI instrument

 As marcas existentes nas limas são indicadores do nível de inserção no porta-limas.

 Esteja atento a quaisquer alterações no ruído quando a lima é activada, de modo a detectar um possível afrouxamento da lima ou do instrumento no porta-limas.

 Markeringerne på filerne indikerer hvor dybt, de skal indsættes i filholderen.

 Lyt efter støjændringer, når filen aktiveres, for at bemærke om filen eller instrumentet eventuelt skulle sidde løst i filholderen.

 Merkene på filene angir hvor langt de skal føres inn i filholderen.

 Lytt etter forandringer i lyden når filen aktiveres for å oppdage om filen eller instrumentet sitter for løst i filholderen.



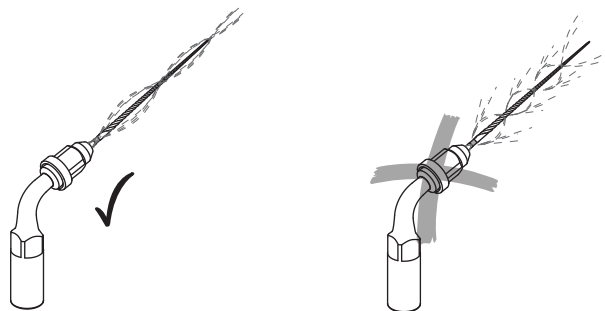

! The spray pattern of irrigation liquid will not be appropriate if the file or the instrument is not properly positioned in the file holder. The file may break, rub the walls of the root canal and enlarge the apex orifice. It is therefore important to verify that this positioning is correctly set.

! Always use the handpiece with the nose cap installed and check that it is correctly tightened.

! Uzorak raspršivanja tekućine za ispiranje neće biti odgovarajući ako igla ili instrument nisu na ispravan način postavljeni u držaču za igle. Igla se može slomiti, očešati stijenke korijenskog kanala i povećati otvor na vrhu korijena. Stoga je važno provjeriti da je njen položaj ispravno podešen.

! Uvijek koristite nasadnik s postavljenim vrhom i provjerite da je ispravno stegnut.

! Het spraypatroon van de irrigatievloeistof zal niet naar behoren zijn als de vijl of het instrument niet goed in de vijlhouder is gepositioneerd. De vijl kan afbreken, de wanden van het wortelkanaal raken en de opening van de wortelpunt verbreden. Daarom is het belangrijk te controleren of deze positionering correct is.

! Gebruik altijd het handstuk met de kap op het uiteinde bevestigd en controleer of deze kap goed is aangedraaid.



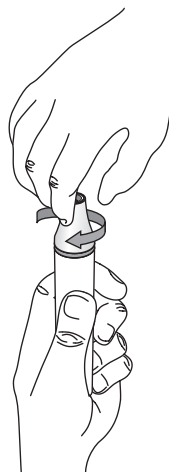



 O padrão de pulverização do líquido de irrigação não será o mais adequado se a lima ou o instrumento não estiver devidamente posicionado no porta-limas. A lima pode quebrar-se, roçar as paredes do canal radicular e alargar o orifício apical. Por isso, é importante verificar se este posicionamento está correctamente definido.

 Use sempre a peça de mão com a tampa cónica colocada, verificando se está correctamente apertada.

 Skyllevæskens strålemønster vil være forkert, hvis filen eller instrumentet ikke sidder korrekt i filholderen. Filen kan knække, gnide mod væggene i rodkanalen og forstørre rodspidsens åbning. Det er derfor vigtigt at verificere, at denne placering er korrekt.

 Anvend altid håndstykket med spidshætten på, og kontroller, at den er korrekt tilspændt.

 Hvis filen eller instrumentet ikke er rigtig plassert i filholderen, sprayer irrigasjonsvæsken ut på feil måte. Filen kan brette, gnis mot veggene i rotkanalen og forstørre apex-åpningen. Det er derfor viktig å kontrollere at den sitter riktig.

 Bruk alltid håndstykket med nesehtten installert og kontroller at den er riktig strammet.



WORKING TECHNIQUE

RADNA TEHNIKA

BEHANDELTECHNIEK

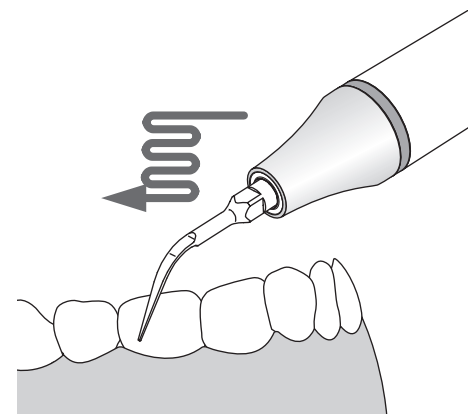
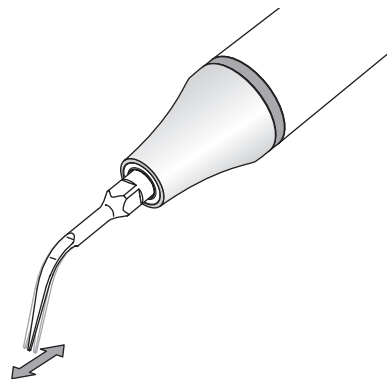
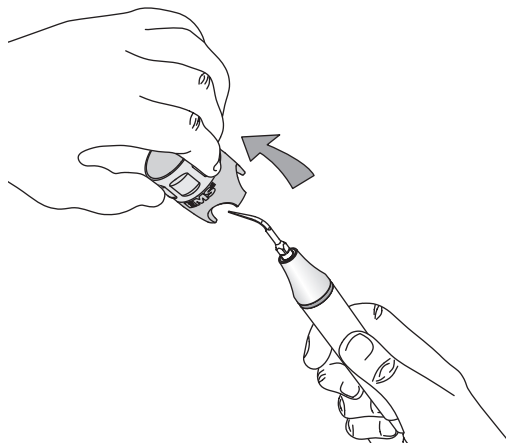

EMS Piezon instruments vibrate in a controlled back and forth oscillation. During treatment, always hold the instrument tangentially to the tooth surface. Move the handpiece similarly to a paintbrush while applying a light lateral pressure.

For a given power setting, long and thin instruments deliver less clinical power, meaning a more gentle treatment for the patient. Shorter instruments can be selected when a higher clinical power is needed.

 Do not direct the instrument straight to the enamel surface. Never point the tip of the instrument to the tooth surface (unless otherwise specified).

EMS Piezon instrumenti vibriraju kontroliranim pomicanjem naprijed-nazad. Za vrijeme tretmana, instrument uvijek treba držati tangентno u odnosu na površinu zuba. Pokrećite nasadnik slično pokretima kista dok primjenjujete lagani lateralni pritisak.

Za postojeće postavke energije, dugi i tanki instrumenti omogućuju manje kliničke snage što znači nježniji tretman za pacijenta. Kraći instrumenti mogu se odabrati kad je potrebna veća klinička snaga.

 Instrument nemojte usmjeriti izravno u površinu cakline. Vrh instrumenta nikad nemojte usmjeriti u površinu zuba (osim ako nije drugačije navedeno).

EMS Piezon-instrumenten trillen in een gecontroleerde, heen en weer gaande beweging. Houd het instrument tijdens de behandeling altijd tangenteel ten opzichte van het tandoppervlak. Beweeg het handstuk als een penseel terwijl u lichte laterale druk uitoefent.

Bij een bepaald vermogen leveren lange en dunne instrumenten minder klinisch vermogen; dit leidt tot een patiëntvriendelijker behandeling. Kortere instrumenten kunnen worden gebruikt wanneer tijdens de klinische behandeling meer vermogen noodzakelijk is.

 Richt het instrument nooit recht op het glazuuroppervlak. Richt de tip van het instrument nooit op het tandoppervlak (tenzij anders aangegeven).





TÉCNICA DE TRABALHO

ARBEJDSTEKNIK

ARBEIDSTEKNIKK

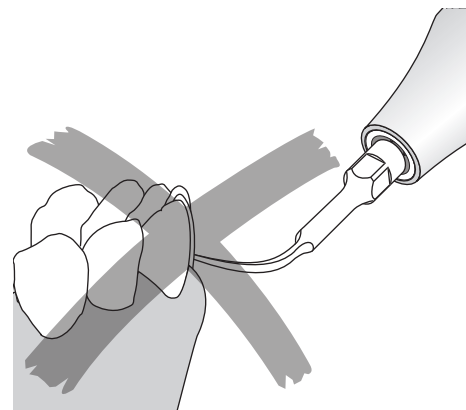
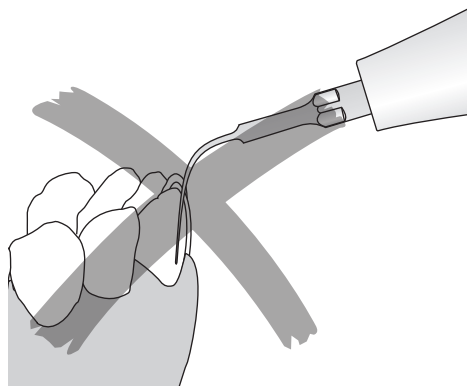

Os instrumentos EMS Piezon vibram num padrão oscilatório longitudinal controlado. Durante o tratamento, segure sempre o instrumento tangencialmente em relação à superfície do dente. Desloque a peça de mão como se fosse um pincel, enquanto aplica uma ligeira pressão lateral.

Para um determinado ajuste de potência, os instrumentos compridos e finos debitam uma menor potência clínica, o que implica um tratamento mais suave para o paciente. Podem seleccionar-se os instrumentos mais curtos quando é necessária uma maior potência clínica.

 Não direcione o instrumento em posição recta contra a superfície do esmalte. Nunca dirija a ponta do instrumento para a superfície do dente (excepto quando existir especificação em contrário).

EMS Piezon-instrumenter vibrerer med en kontrolleret fremad- og tilbagegående oscillation. Hold altid instrumentet, så det berører tandoverfladen under behandlingen. Flyt håndstykket på samme måde som en malerpensel, mens der påføres et let lateralt tryk.

Lange og tynde instrumenter leverer ved en bestemt effektindstilling mindre klinisk styrke, hvilket er ensbetydende med en mere blid behandling af patienten. Der kan vælges kortere instrumenter, når der er behov for en højere klinisk styrke.

 Ret ikke instrumentet lige mod emaljeoverfladen. Ret aldrig instrumentspidsen mod tandoverfladen (medmindre andet er angivet).

EMS Piezon-instrumentene vibrerer i en kontrollert oscillasjon frem og tilbake. Hold alltid instrumentet tangentielt mot tannoverflaten under behandlingen. Beveg håndstykket på samme måte som en pensel og påfør et lett lateralt trykk.

Ved en gitt effektinnstilling gir lange og tynde instrumenter mindre klinisk effekt, noe som gir pasienten en mildere behandling. Kortere instrumenter kan velges hvis høyere klinisk effekt er nødvendig.

 Ikke rett instrumentet rett mot emaljeoverflaten. Spissen av instrumentet må aldri peke mot tannoverflaten (med mindre annet er angitt).





Diamond-coated instruments

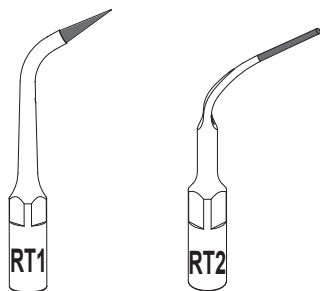

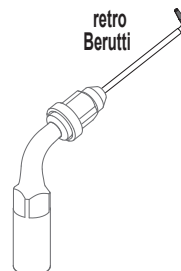

Dijamantno presvučeni instrumenti



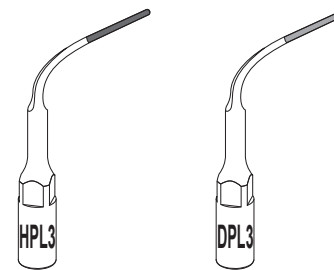

Diamantinstrumenten





 The diamond-coated instruments are very efficient. Always use them with sufficient irrigation flow to avoid damaging hard and soft tissues and reduce wear.

 The ultrasound vibrations cannot be delivered properly when the tip of the instrument is under heavy load. A gentle pressure on the instrument will free its full effective power without risk for the tissues, and enable a noteworthy wear reduction.

 Visually inspect the diamond coating before use. A worn coating greatly reduces the efficiency.

 Dijamantno presvučeni instrumenti su vrlo učinkoviti. Uvijek ih koristite s dovoljnim mlazom za ispiranje kako biste izbjegli oštećenja na tvrdim i mekim tkivima i smanjili trošenje.

 Ultrazvučne vibracije ne mogu ispravno prodrijeti ako je vrh instrumenata pod teškim naporom. Lagani pritisak na instrument oslobodit će cijelu učinkovitu snagu bez opasnosti za tkiva i omogućiti značajno smanjenje od trošenja.

 Vizualno provjerite dijamantnu presvlaku prije uporabe. Istrošena presvlaka značajno smanjuje učinkovitost.

 Diamantinstrumenten zijn bijzonder efficiënt. Gebruik ze altijd met voldoende irrigatie om beschadiging van harde en weke delen te voorkomen en slijtage te verminderen.

 Wanneer de tip van het instrument zwaar wordt belast, kunnen de ultrasone trillingen niet goed worden afgegeven. Een lichte druk op het instrument zal het effectieve vermogen zonder risico voor de weefsels helemaal tot zijn recht laten komen en leiden tot een opmerkelijke afname van de slijtage.

 Inspecteer de diamantcoating voor gebruik. Een afgesleten coating vermindert de doelmatigheid aanzienlijk.





Instrumentos diamantados

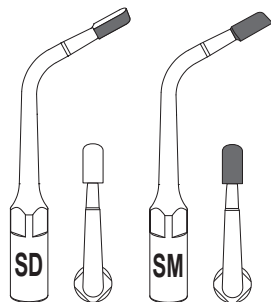

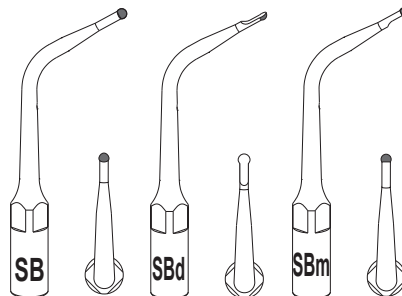

Diamantbelagte instrumenter



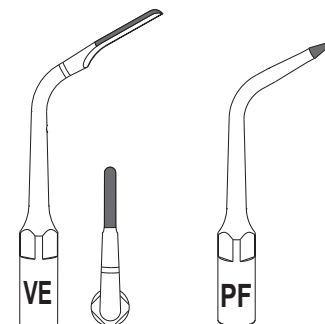

Diamantbelagte instrumenter





 Os instrumentos diamantados são muito eficientes. Use-os sempre com um caudal de irrigação suficiente para evitar danos em tecidos duros e moles e para reduzir o desgaste.

 Não é possível aplicar devidamente as vibrações ultrassônicas quando a ponta do instrumento se encontra sob uma carga significativa. Uma ligeira pressão sobre o instrumento libertará toda a sua potência útil sem risco para os tecidos, permitindo uma redução significativa do desgaste.

 Inspeccione visualmente o revestimento diamantado antes de utilizar. Um revestimento desgastado reduz em muito a eficiência.

 De diamantbelagte instrumenter er meget effektive. Brug dem altid med et tilstrækkeligt stort skylleflow for at undgå at beskadige knogler og bløddel og for at reducere slid.

 Ultralydvibrationerne kan ikke leveres korrekt, når instrumentspidsen er under stor belastning. Et let tryk på instrumentet vil frigøre dets fulde effektive styrke uden risiko for vævet og muliggøre en bemærkelsesværdig slidreduktion.

 Efterse diamantbelægningen før brug. En slidt belægning reducerer effektiviteten kraftigt.

 Diamantbelagte instrumenter er svært effektive. De må alltid brukes med tilstrekkelig irrigasjonsstrøm for å unngå å skade hardt og mykt vev og redusere slitasje.

 Ultralydvibrasjonene avgis på feil måte hvis trykket på instrumentet er for høyt. Et lett trykk på instrumentet gir full effekt uten risiko for vevet og reduserer slitasjen betraktelig.

 Inspiser diamantbelegget visuelt før bruk. Et slitt belegg reduserer effekten betraktelig.





SCALING

 Avoid using the HVE (high volume evacuation) to ensure sufficient cooling of the tooth and the instrument. The instrument heats up quickly if the irrigation flow rate is not enough.

Instrument A

Universal scaling instrument for removing supragingival deposits in all quadrants.

Instrument B

Instrument for removing large supragingival deposit in all quadrants. It can be used for removing remains of orthodontic cements.

Instrument P

Instrument for removing supra or subgingival deposits in all quadrants, particularly in the interproximal and the sulcus areas.

Instrument PS

Slim instrument for subgingival fine scaling and for root debridement.

Instrument PSR and PSL

Instruments PSR (left-curved) and PSL (right-curved) are used for debridement and provide easy access to interproximal areas.

Implants and restorations cleaning

Instrument PI (on file holder)

Specific instrument for removing plaque and calculus from the surface of implants and from metal or ceramic restorations.

UKLANJANJE ZUBNOG KAMENCA

 Izbjegavajte korištenje HVE-a (evakuatora velikog kapaciteta) kako biste osigurali dostatno hlađenje zuba i instrumenta. Instrument se brzo zagrijava ako stopa ispiranja nije dovoljna.

Instrument A

Univerzalni instrument za uklanjanje supragingivalnih naslaga u svim kvadrantima.

Instrument B

Instrument za uklanjanje velikih supragingivalnih naslaga u svim kvadrantima. Može se koristiti za uklanjanje ostataka ortodontskih cemenata.

Instrument P

Instrument za uklanjanje supra i subgingivalnih naslaga u svim kvadrantima, posebno u interproximalnom i sulkusnom području.

Instrument PS

Tanki instrument za subgingivalno fino čišćenje i za debridman korijena.

Instrumenti PSR i PSL

Instrumenti PSR (zakrivljen udesno) i PSL (zakrivljen ulijevo) upotrebljavaju se za čišćenje i omogućuju jednostavan pristup interproximalnim područjima.

Čišćenje implantata i restauracija

Instrument PI (na držaču za igle)

Posebni instrument za uklanjanje plaka i kamenca s površine implantata ili s metalnih ili keramičkih restauracija.

SCALING

 Gebruik geen krachtige afzuiging om een afdoende koeling van element en instrument veilig te stellen. Als de irrigatiestroom onvoldoende is, wordt het instrument namelijk snel warm.

Instrument A

Universeel scalinginstrument voor verwijdering van supragingivale afzettingen in alle kwadranten.

Instrument B

Instrument voor verwijdering van aanzienlijke supragingivale afzetting in alle kwadranten. Het kan worden gebruikt voor het verwijderen van resten van orthodontisch cement.

Instrument P

Instrument voor het verwijderen van supra- of subgingivale afzettingen in alle kwadranten, met name interproximaal en in het sulcusgebied.

Instrument PS

Dun instrument voor fijne subgingivale scaling en worteldebridement.

Instrumenten PSR en PSL

De instrumenten PSR (naar rechts gebogen) en PSL (naar links gebogen) worden gebruikt voor wondzorg en zorgt voor eenvoudig bereik van interproximale gedeeltes.

Reiniging van implantaten en restauraties

Instrument PI (op vijlhouder)

Specifiek instrument voor het verwijderen van plaque en tandsteen van het oppervlak van implantaten en van metalen of keramische restauraties.



DESTARTARIZAÇÃO

 Evite usar a aspiração de volume elevado (HVE) para assegurar um arrefecimento suficiente do dente e do instrumento. O instrumento aquece rapidamente se o caudal de irrigação não for suficiente.

Instrumento A

Instrumento universal de destartarização para remoção de depósitos supragengivais em todos os quadrantes.

Instrumento B

Instrumento para a remoção de grandes depósitos supragengivais em todos os quadrantes. Pode ser usado para a remoção de resíduos de cimentos ortodônticos.

Instrumento P

Instrumento para a remoção de depósitos supra ou subgingivais em todos os quadrantes, particularmente nas áreas interproximais e do sulco gengival.

Instrumento PS

Instrumento delgado para a destartarização subgingival de depósitos mais finos e para desbridamento radicular.

Instrumentos PSR e PSL

Os instrumentos PSR (curvados à direita) e PSL (curvados à esquerda) são utilizados para o desbridamento e possibilitam o fácil acesso às áreas interproximais.

Limpeza de implantes e reconstruções

Instrumento PI (no porta-limas)

Instrumento específico para a remoção de placa e cálculos da superfície de implantes e de reconstruções metálicas ou cerâmicas.

TANDRENSNING

 Undgå at bruge HVE (high volume evacuation) for at sikre tilstrækkelig afkøling af tanden og instrumentet. Instrumentet ophedes hurtigt, hvis skyllegennemstrømningens hastighed ikke er tilstrækkelig stor.

Instrument A

Universelt tandrensningsinstrument til fjernelse af supragingivale tandsten i alle kvadranter.

Instrument B

Instrument til fjernelse af store supragingivale tandsten i alle kvadranter. Det kan anvendes til at fjerne rester af ortodontisk cement.

Instrument P

Instrument til fjernelse af supra- eller subgingivale tandsten i alle kvadranter, især i interproximale rum og i sulcus.

Instrument PS

Tyndt instrument til fin subgingival tandrensning og roddebridering.

Instrumenterne PSR og PSL

Instrumenterne PSR (højrebuet) og PSL (venstrebuget) bruges til debridement og giver nem adgang til interproximale områder.

Rensning af implantater og rekonstruktioner

Instrument PI (på filholder)

Særligt instrument til fjernelse af plak og tandsten fra overfladen på implantater og fra metal- eller keramiske rekonstruktioner.

SCALING

 Unngå å bruke HVE (High Volume Evacuation) for å sikre tilstrekkelig avkjøling av tannen og instrumentet. Instrumentet blir raskt varmt hvis irrigasjonsstrømmen er for lav.

Instrument A

Universelt scaling-instrument til fjernelse av supragingivalt belegg i alle kvadranter.

Instrument B

Instrument til fjernelse av kraftig supragingivalt belegg i alle kvadranter. Kan brukes til fjernelse av rester av ortodontisement.

Instrument P

Instrument til fjernelse av supra- eller subgingivalt belegg i alle kvadranter, spesielt i interproximale områder og sulcusområder.

Instrument PS

Tynt instrument til presis subgingival scaling og rotdebridering.

Instrumenter PSR and PSL

Instrument PSR (høyrebuet) og Instrument PSL (venstrebuget) brukes til debridement og gir lett adgang til interproximale områder.

Rengjøring av implantater og rekonstruksjoner

Instrument PI (i filholder)

Spesifikt instrument til fjernelse av plakk og tannstein fra implantatoverflaten og fra rekonstruksjoner av metall eller keramikk.



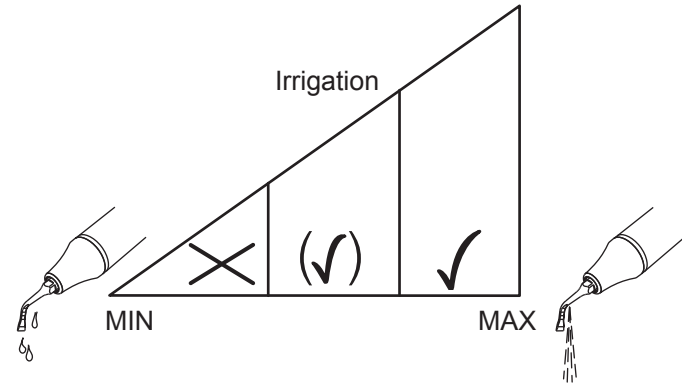
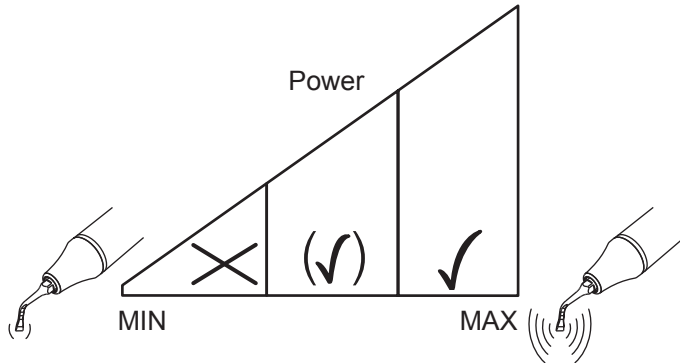
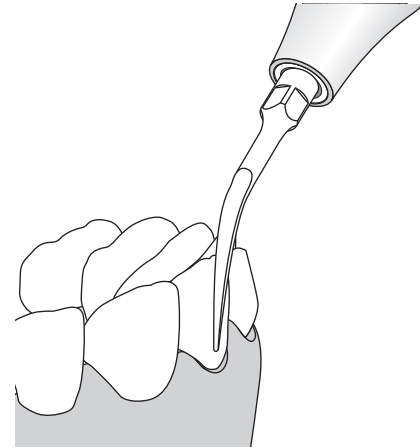
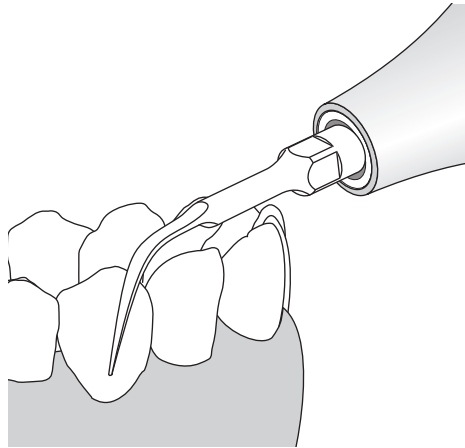
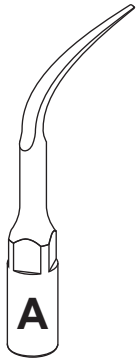



Instrument A for universal scaling

Removal of supragingival deposits in all quadrants.

Use a high power setting for hard concretions and for initial treatment, or a medium power setting for pain-sensitive patients.

Use a high to medium irrigation flow rate.

Instrument A za univerzalno uklanjanje kamenca

Uklanjanje supragingivalnih naslaga u svim kvadrantima.

Koristite visoke postavke energije za tvrde naslage zubnog kamenca i za početni tretman ili niske postavke energije za pacijente osjetljive na bol.

Koristite visoku do srednju razinu mlaza za ispiranje.

Instrument A voor universele scaling

Verwijdering van supragingivale afzettingen in alle kwadranten.

Gebruik een hoog vermogen voor hard tandsteen en voor de initiële behandeling, of een middelmatig vermogen voor pijngevoelige patiënten.

Gebruik een hoge tot middelhoge irrigatiestroom.

SCALING

Instrumento A para destarização universal

Remoção de depósitos supragengivais em todos os quadrantes.

Use um ajuste de potência elevada para cálculos duros e para o tratamento inicial ou um ajuste médio para pacientes mais sensíveis à dor.

Use um caudal de irrigação elevado a médio.

Instrument A til universel tandrensning

Fjernelse af supragingivale tandsten i alle kvadranter.

Anvend en høj indstilling af effekten ved hårde tandsten og som indledende behandling eller en middelindstilling til smertefølsomme patienter.

Anvend en høj til middel hastighed for skyllegennemstrømningen.

Instrument A til universell scaling

Fjerning av supragingivalt belegg i alle kvadranter.

Bruk høy effekt ved hard tannstein og ved innledende behandling, eller middels effekt til pasienter som er følsomme for smerter.

Bruk høy til middels irrigasjonsstrøm.



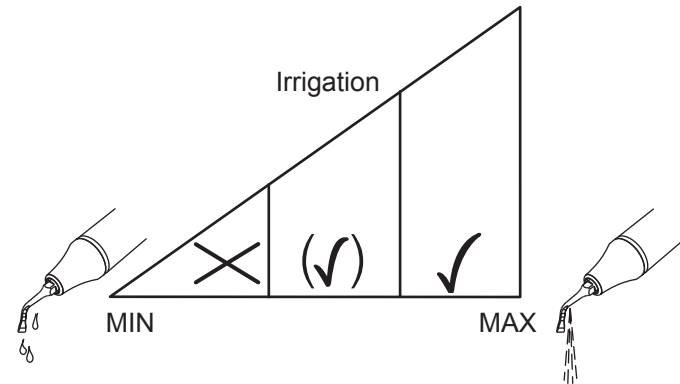
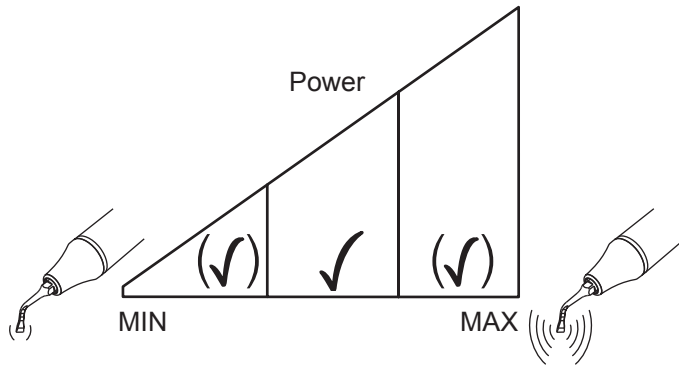
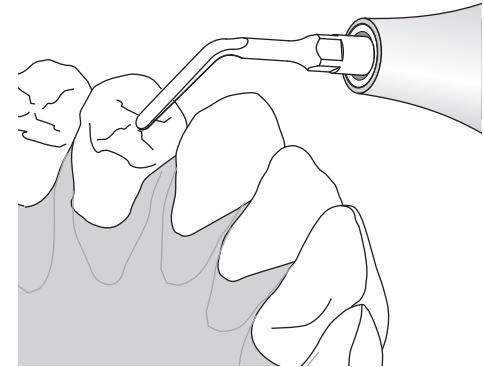
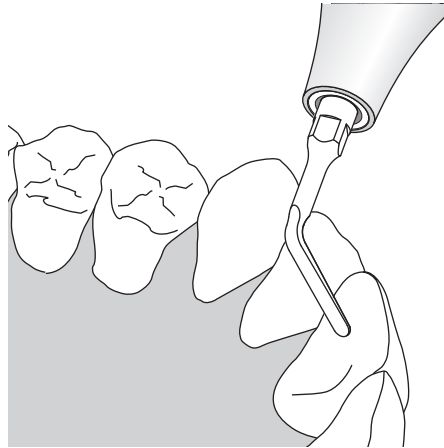
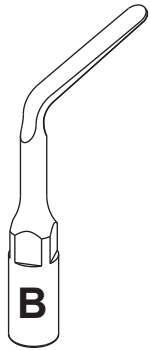



Instrument B for lingual scaling

Removal of large supragingival deposits on the lingual surfaces in all quadrants. Removal of orthodontic cements.

Use a medium power setting, or low power setting for pain-sensitive patients. Use a high power setting for hard concretions.

Use a high to medium irrigation flow rate.

 The rounded tip can be used at low power to remove thin lingual or occlusal deposits.

Instrument B za uklanjanje lingvalnog kamenca

Uklanjanje širokih supragingivalnih naslaga na lingvalnim površinama u svim kvadrantima. Uklanjanje ortodontskih cemenata.

Koristite srednje ili niže postavke energije za pacijente osjetljive na bol. Koristite visoke postavke energije za tvrde naslage zubnog kamenca.

Koristite visoku do srednju razinu mlaza za ispiranje.

 Zaobljeni vrh može se koristiti kod niskih postavki energije za uklanjanje tankih lingvalnih ili okluzijskih naslaga.

Instrument B voor linguale scaling

Verwijdering van grote supragingivale afzettingen op de linguale oppervlakken in alle kwadranten. Verwijdering van orthodontisch cement.

Gebruik een middelhoog of laag vermogen voor pijngevoelige patiënten. Gebruik een hoog vermogen voor hard tandsteen.

Gebruik een hoge tot middelhoge irrigatiestroom.

 De afgeronde tip kan met een laag vermogen worden gebruikt voor het verwijderen van dunne linguale of occlusale afzettingen.

Instrumento B para destarização lingual

Remoção de grandes depósitos supragingivais nas superfícies linguais em todos os quadrantes. Remoção de cimentos ortodônticos.

Use um ajuste de potência média ou baixa para pacientes sensíveis à dor. Use um ajuste de potência elevada para cálculos duros.

Use um caudal de irrigação elevado a médio.

 A ponta arredondada pode ser usada com baixa potência para remover depósitos linguais ou oclusais finos.

Instrument B til lingualtandrensning

Fjernelse af store supragingivale tandsten på alle lingualflader i alle kvadranter. Fjernelse af ortodontisk cement.

Anvend en middel eller en lav effektindstilling til smertefølsomme patienter. Anvend en høj indstilling af effekten ved hårde tandsten.

Anvend en høj til middel hastighed for skyllegenemstrømningen.

 Den afrundede spids kan anvendes ved lav effekt til at fjerne tynde linguale eller okklusale tandsten.

Instrument B til lingual scaling

Fjerning av kraftig supragingivalt belegg på linguale overflater i alle kvadranter. Fjerning av ortodontisement.

Bruk middels effekt, eller lav effekt til pasienter som er følsomme for smerter. Bruk høy effekt ved hard tannstein.

Bruk høy til middels irrigasjonsstrøm.

 Den avrundede spissen kan brukes ved lav effekt til å fjerne tynt lingualt eller okklusalt belegg.



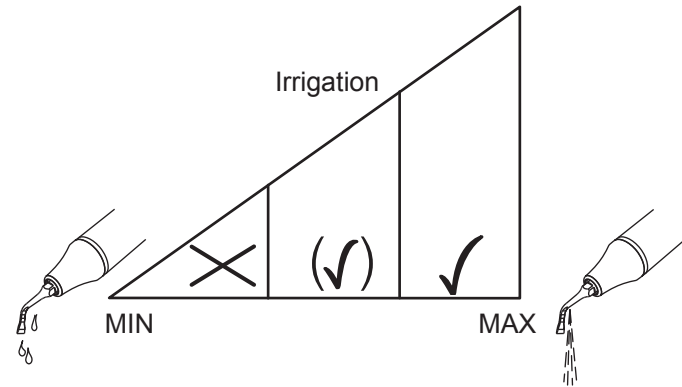
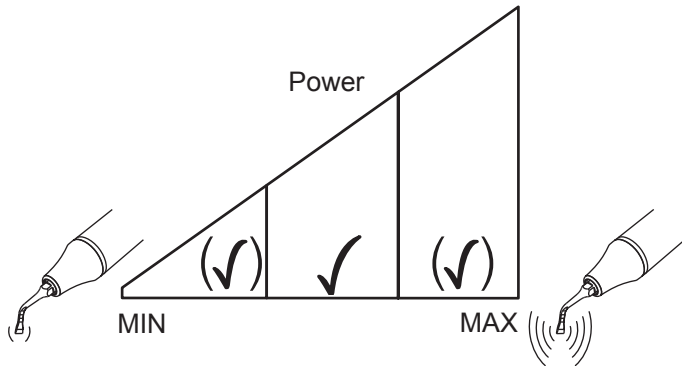
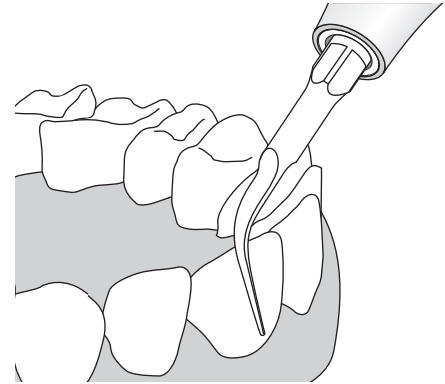
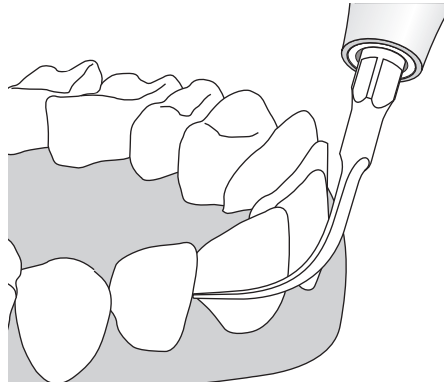
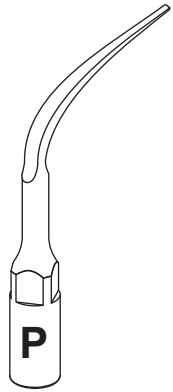



Instrument perio P

Removal of supra and subgingival deposits in all quadrants, including the interproximal and sulcus areas.

Use a medium power setting, or low power setting for pain-sensitive patients and for supragingival maintenance-type treatments. Use a high power setting for hard concretions.

Use a high to medium irrigation flow rate.

Instrument perio P

Uklanjanje supra i subgingivalnih naslaga u svim kvadrantima, uključujući interproksimalna i sulkusna područja.

Koristite srednje ili niže postavke energije za pacijente osjetljive na bol i za tretmane poput supragingivalnog održavanja. Koristite visoke postavke energije za tvrde naslage zubnog kamenca.

Koristite visoku do srednju razinu mlaza za ispiranje.

Instrument perio P

Verwijdering van supra- en subgingivale afzettingen in alle kwadranten, inclusief interproximaal en in het sulcusgebied.

Gebruik een middelhoog vermogen, of een laag vermogen voor pijngevoelige patiënten en voor supragingivale onderhoudsbehandelingen. Gebruik een hoog vermogen voor hard tandsteen.

Gebruik een hoge tot middelhoge irrigatiestroom.

Instrumento perio P

Remoção de depósitos supra e subgingivais em todos os quadrantes, incluindo as áreas interproximais e do sulco gengival.

Use um ajuste de potência média ou baixa para pacientes sensíveis à dor e para tratamentos suragengivais de manutenção. Use um ajuste de potência elevada para cálculos duros.

Use um caudal de irrigação elevado a médio.

Instrument perio P

Fjernelse af supra- og subgingivale tandsten i alle kvadranter, inklusive i interproksimale rum og i sulcus.

Anvend en middel eller en lav effektindstilling til smertefølsomme patienter og til supragingivale vedligeholdelsesbehandlinger. Anvend en høj indstilling af effekten ved hårde tandsten.

Anvend en høj til middel hastighed for skyllegenemstrømningen.

Perio-instrument P

Fjerning av supra- og subgingivalt belegg i alle kvadranter, inkludert i interproksimale områder og sulcusområder.

Bruk middels effekt, eller lav effekt til pasienter som er følsomme for smerter og ved supragingival vedlikeholdsbehandling. Bruk høy effekt ved hard tannstein.

Bruk høy til middels irrigasjonsstrøm.



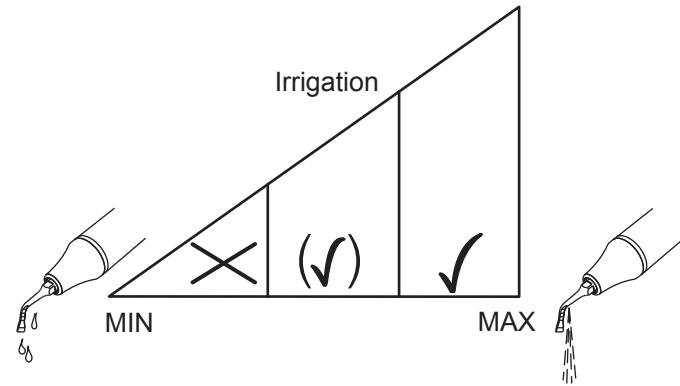
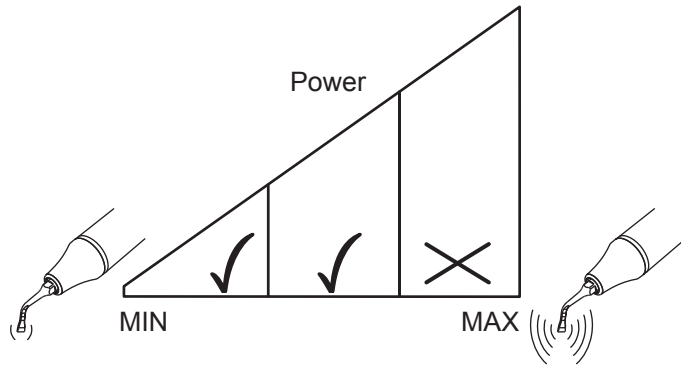
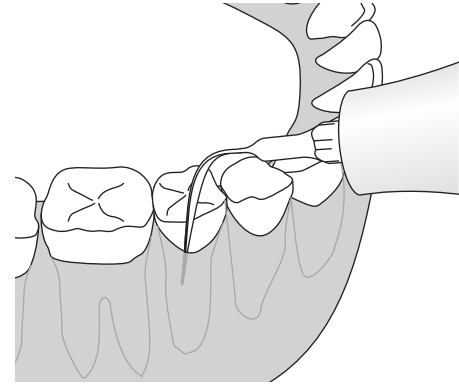
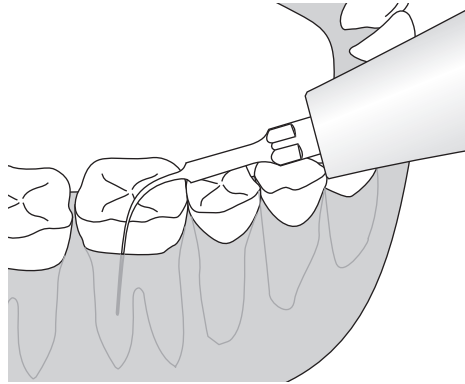
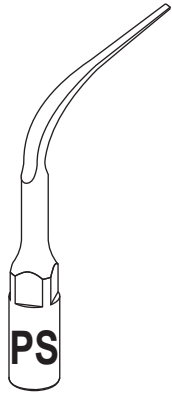



Instrument perio slim PS

Supragingival and subgingival removal of calculus up to 10mm from natural teeth.

Can be used with low and high power.

Water setting should range between 70-100%.

Instrument perio slim PS

Supragingivalno i subgingivalno uklanjanje kamenca do 10 mm s prirodnih zuba.

Može se upotrebljavati uz nisku i visoku snagu.

Postavka vode mora biti između 70 – 100 %.

Instrument perio dun PS

De verwijdering van supragingivaal en subgingivaal tandvlees tot 10 mm van de natuurlijke tanden.

Kan gebruikt worden met hoog en laag vermogen.

Waterinstellingen moeten variëren tussen 70 en 100%.

SCALING



Instrumento perio slim PS

Remoção supragengival e subgengival de cálculos até 10mm dos dentes naturais.

Pode ser utilizado com baixa e alta potências.

O nível da água deve variar entre 70-100%.

Instrument perio tynd PS

Supragingival og subgingival fjernelse af tandsten op til 10mm fra naturlig tand.

Kan bruges med lav og høj effekt.

Vandindstillingen bør ligge mellem 70-100%.

Tynt perio-instrument PS

Fjerning av supragingival og subgingival tannstein opptil 10 mm fra naturlige tenner.

Kan brukes med lav og høy effekt.

Vanninnstillingen må være mellom 70 og 100 %.



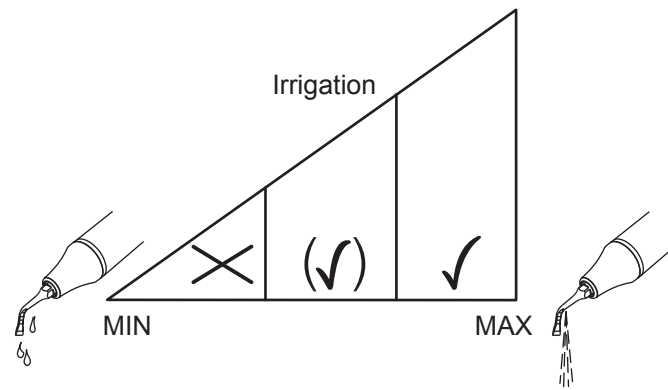
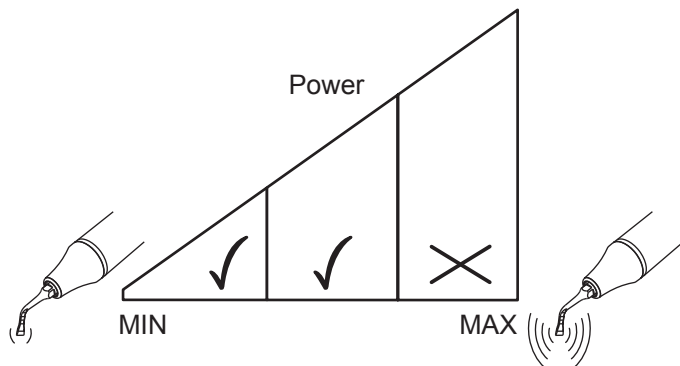
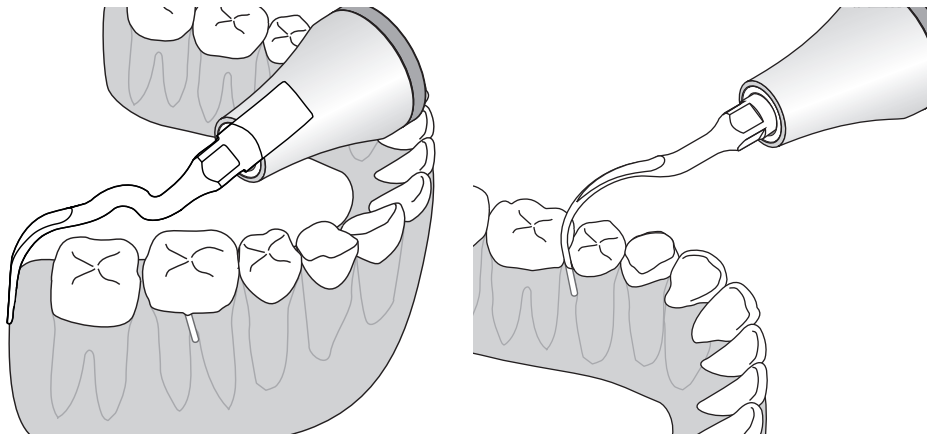
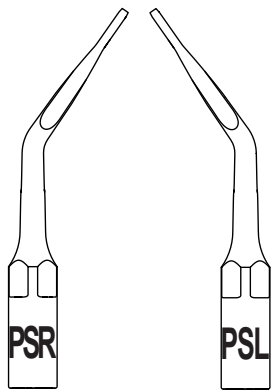



Instruments PSR and PSL

Supragingival and subgingival removal of calculus up to 8mm from natural teeth providing easy access to interproximal areas.

Can be used with maximum 60% power.

Water setting should range between 70-100%.



Do not direct the instrument straight to the enamel surface. Never point the tip of the instrument to the tooth surface.

Instrumenti PSR i PSL

Supragingivalno i subgingivalno uklanjanje kamenca do 10 mm s prirodnih zuba.

Može se upotrebljavati uz nisku i visoku snagu.

Postavka vode mora biti između 70 – 100 %.



Instrument nemojte usmjeriti izravno u površinu cakline. Nikad nemojte usmjeriti vrh instrumenta prema površini zuba.

Instrumenten PSR en PSL

De verwijdering van supragingivaal en subgingivaal tandvlees tot 10 mm van de natuurlijke tanden.

Kan gebruikt worden met hoog en laag vermogen.

Waterinstellingen moeten variëren tussen 70 en 100%.



Richt het instrument nooit recht op het glazuerooppervlak. Richt de tip van het instrument nooit op het tandoppervlak.

SCALING

Instrumentos PSR e PSL

Remoção supragengival e subgengival de cálculos até 10mm dos dentes naturais.

Pode ser utilizado com baixa e alta potências.

O nível da água deve variar entre 70-100%.



Não direcione o instrumento em posição recta contra a superfície do esmalte. Nunca dirija a ponta do instrumento para a superfície do dente.

Instrumenterne PSR og PSL

Supragingival og subgingival fjernelse af tandsten op til 10mm fra naturlig tand.

Kan bruges med lav og høj effekt.

Vandindstillingen bør ligge mellem 70-100%.



Ret ikke instrumentet lige mod emaljefladen. Ret aldrig instrumentspidsen mod tandfladen.

Instrumenter PSR and PSL

Fjerning av supragingival og subgingival tannstein opptil 10 mm fra naturlig tenner.

Kan brukes med lav og høy effekt.

Vanninnstillingen må være mellom 70 og 100 %.



Ikke rett instrumentet rett mot emaljeoverflaten. Spissen av instrumentet må aldri peke mot tannoverflaten.



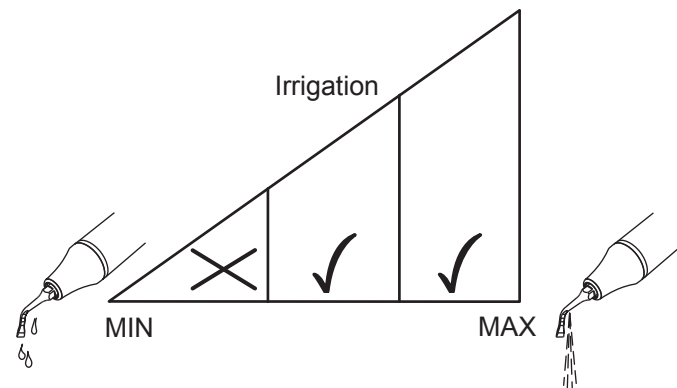
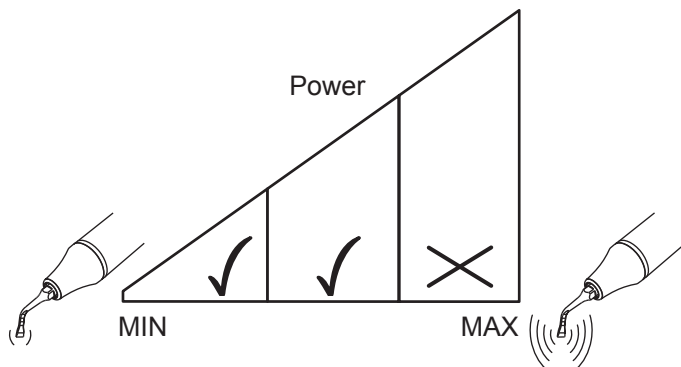
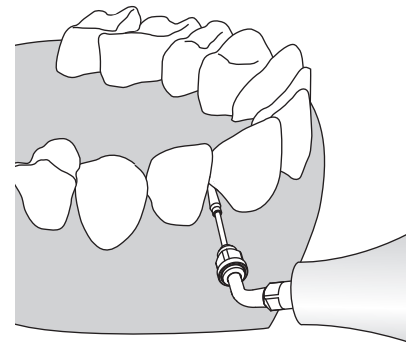
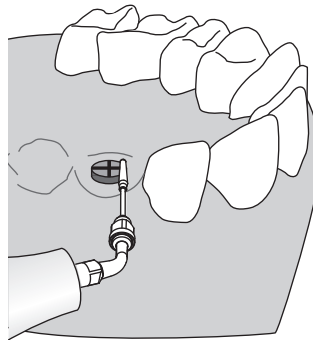
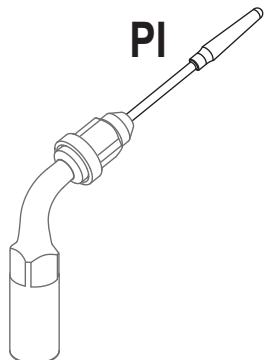



Specific instrument PI for implants cleaning

Removal of plaque and calculus from the surface of implants and from metal or ceramic restorations. Surface cleaning on prosthesis units. Must be used with a 120° file holder.

Use a low power setting or medium power for hard concrements.

Use a high to medium irrigation flow rate.

 Verify that the plastic coating is not worn or damaged before use. We recommend to use a rubber dam to prevent the patient from accidentally swallowing or inhaling debris. When a rubber dam cannot be used, instruct the patient to breathe through the nose.

Instrumento específico PI para limpeza de implantes

Remoção de placa e cálculos da superfície de implantes e de reconstruções metálicas ou cerâmicas. Limpeza de superfície em unidades protésicas. Tem de ser usado com um porta-limas de 120°.

Use um ajuste de potência baixa ou média para cálculos duros.

Use um caudal de irrigação elevado a médio.

 Verifique se o revestimento plástico não está desgastado ou danificado, antes de utilizar. Recomendamos a utilização de um dique de borracha para impedir que o paciente engula ou inspire acidentalmente alguns resíduos. Quando não for possível utilizar um dique de borracha, instrua o paciente para respirar pelo nariz.

Posebni instrument PI za čiščenje implantata

Uklanjanje plaka i kamenca s površine implantata i s metalnih ili keramičkih restauracija. Površinsko čišćenje na protetskim jedinicama. Mora se koristiti s držačem za iglu od 120°.

Koristite niske ili srednje postavke energije za tvrde naslage zubnog kamenca.

Koristite visoku do srednju razinu mlaza za ispiranje.

 Prije uporabe povjerite da plastični premaz nije istrošen ili oštećen. Preporučamo korištenje koferdama kako biste spriječili da pacijent slučajno proguta ili udahne sitne čestice. Ako se koferdam ne može upotrijebiti, uputite pacijenta da diše kroz nos.

Specialinstrument PI til rensning af implantater

Fjernelse af plak og tandsten fra overfladen på implantater og fra metal- eller keramiske rekonstruktioner. Overfladerensning af proteseeheder. Kan anvendes sammen med en 120° filholder.

Anvend en lav eller middel effektindstilling ved hårde tandsten.

Anvend en høj til middel hastighed for skyllegenemstrømningen.

 Kontroller, at plasticbelægningen ikke er slidt eller beskadiget før brug. Vi anbefaler at anvende en koferdam for at forhindre, at patienten kommer til at sluge eller indånde debris. Hvis der ikke kan anvendes en koferdam, skal patienten instrueres i at trække vejret gennem næsen.

Specifiek instrument PI voor reiniging van implantaten

Verwijdering van plaque en tandsteen van het oppervlak van implantaten en van metalen of keramische restauraties. Oppervlaktereiniging van protheseonderdelen. Moet worden gebruikt met een 120° vijlhouder.

Gebruik een laag of middelhoog vermogen voor hard tandsteen.

Gebruik een hoge tot middelhoge irrigatiestroom.

 Controleer voor gebruik of de plastic coating niet is afgesleten of beschadigd. We adviseren een rubberdam te gebruiken om te voorkomen dat de patiënt per ongeluk deeltjes doorslikt of inhaleert. Instrueer de patiënt door de neus te ademen wanneer er geen rubberdam kan worden gebruikt.

Specialinstrument PI til rengjøring av implantater

Fjerning av plakk og tannstein fra overflaten av implantater og fra rekonstruksjoner av metall eller keramikk. Overflaterengjøring på proteser. Må brukes med en 120° filholder.

Bruk lav effekt eller middels effekt ved hard tannstein.

Bruk høy til middels irrigasjonsstrøm.

 Kontroller at plastbelegget ikke er slitt eller skadet før bruk. Vi anbefaler å bruke en gummiduk for å hindre at pasienten svelger eller inhalerer løse rester. Hvis dette ikke kan brukes, må pasienten få beskjed om å puste gjennom nesen.





ENDO

Files for the orthograde therapy

K-type files (on file holder)

Stainless steel endo files activated by high frequencies for shaping, cleaning and disinfecting the root canal system. Available in sizes ISO 15 to ISO 35, they can be used with a 90° or a 120° file holder.

ESI file (on file holder)

NiTi file in size ISO 15 for cleaning and irrigation of the root canal system. A 120° or a 90° file holder can be used.

 Never activate the files without irrigation and never operate them outside the root canal otherwise they will break (except for 2 sec. during the setting of the irrigation).

 To prevent file from breaking, create a glide path with a hand endo file and plan for an access as straight as possible to limit file twisting. Use a light touch-retract motion without rush. Often examine the file for detection of signs of fatigue. In application of the precautionary principle, replace the file as soon as possible.

ENDODONCIJA

Igla za ortogradnu terapiju

Igla K tipa (na držaču za igle)

Igla za endodonciju od nerđajućeg čelika aktivirane visokim frekvencijama za oblikovanje, čišćenje i dezinfekciju sustava korijenskih kanala. Raspoložive u veličinama ISO 15 do ISO 35 i mogu se upotrijebiti s držačem za igle 90° ili 120°.

ESI igla (na držaču za igle)

NiTi igla u veličini ISO 15 za čišćenje i ispiranje sustava korijenskih kanala. Može se koristiti držač za igle 120° ili 90°.

 Nikad ne aktivirajte igle bez ispiranja i nikad ih ne uključujte izvan korijenskog kanala jer bi se mogle slomiti (osim 2 sekunde tijekom podešavanja ispiranja).

 Kako biste spriječili da se igla slomi, kreirajte pristup pomoću ručne endodontske igle i planirajte pristup što je ravnije moguće kako biste ograničili zakretanje igle. Koristite lagani pokret gore-dolje bez žurbe. Često provjeravajte iglu kako biste otkrili znakove zamora. Iz predostrožnosti zamijenite iglu što je prije moguće.

ENDO

Vijlen voor orthograde behandeling

K-vijlen (op vijlhouder)

Roestvrijstalen endovijlen geactiveerd door hoge frequenties voor vormgeving, reiniging en desinfectie van het wortelkanaalsysteem. Ze zijn verkrijgbaar in de maten ISO nr. 15 tot ISO nr. 35 en kunnen worden gebruikt met een 90° of een 120° vijlhouder.

ESI-vijl (op vijlhouder)

NiTi-vijl in de maat ISO nr. 15 voor reiniging en irrigatie van het wortelkanaalsysteem. Er kan een 120° of een 90° vijlhouder worden gebruikt.

 Activeer de vijlen nooit zonder irrigatie en gebruik ze nooit buiten het wortelkanaal, anders breken ze (behalve gedurende 2 sec. tijdens het instellen van de irrigatie).

 Maak een glijpad met een handmatige endovijl en plan een zo recht mogelijke toegang om draaien van de vijl en afbreken ervan te voorkomen. Gebruik een rustige beweging van licht aanraken en terugtrekken. Controleer de vijl veelvuldig op tekenen van moeheid. Vervang de vijl uit voorzorg zo snel mogelijk.



ENDODONTIA

Limas para terapia ortógrada

Limas tipo K (no porta-limas)

Limas endodônticas em aço inoxidável activadas por altas frequências para modelação, limpeza e desinfecção do sistema do canal radicular. Disponíveis nos tamanhos ISO 15 a ISO 35, podem ser usadas com um porta-limas de 90° ou 120°.

Lima ESI (no porta-limas)

Lima NiTi no tamanho ISO 15 para limpeza e irrigação do sistema do canal radicular. Pode ser usado um porta-limas de 120° ou 90°.

 Nunca active as limas sem irrigação e nunca as opere fora do canal radicular para não quebrarem (excepto durante 2 seg. durante o ajuste da irrigação).

 Para evitar que as limas quebrem, crie um percurso de deslizamento com uma lima endodôntica manual e planeie um acesso o mais recto possível, de modo a limitar as torções da lima. Use um movimento ligeiro de toque-retracção sem precipitação. Examine frequentemente a lima para verificar a existência de sinais de fadiga. Por precaução, substitua a lima logo que possível.

ENDODONTI

Filer til ortograd behandling

K-filer (på filholder)

Højfrekvensaktiverede endofiler af rustfrit stål til at formgive, rense og desinficere rodkanalsystemet. Leveres i størrelserne ISO/15 til ISO 35. De kan anvendes sammen med en 90° eller en 120° filholder.

ESI-fil (på filholder)

NiTi-fil i størrelse ISO/15 til at rense og skylle rodkanalsystemet. Der kan anvendes en 120° eller en 90° filholder.

 Aktiver aldrig filerne uden at skylle og brug dem aldrig uden for rodkanalen, da de ellers vil knække (undtagen i 2 sekunder under indstillingen af skylningen).

 Undgå, at filen knækker ved at oprette en glidebane med en håndendofil, og beregn en adgang, der er så lige som mulig for at begrænse drejningen af filen. Foretag en bevægelse med let berøring og tilbageslækning uden hastværk. Undersøg ofte filen for tegn på træthed. Udskift filen snarest muligt som sikkerhedsforanstaltning.

ENDODONTI

Filer til ortograd behandling

K-filer (i filholder)

Endodontifiler av rustfritt stål som aktiveres av høye frekvenser til forming, rengjøring og desinfisering av rotkanalsystemet. Fås i størrelsene ISO 15 til ISO 35 og kan brukes med en 90° eller 120° filholder.

ESI-fil (i filholder)

NiTi-fil i størrelsen ISO 15 til rengjøring og irrigasjon av rotkanalsystemet. En 120° eller 90° filholder kan brukes.

 Filene må aldri aktiveres uten irrigasjon og aldri brukes utenfor rotkanalen, det vil føre til at de bryter (bortsett fra 2 sekunder under innstilling av irrigasjonen).

 For å hindre at filen bryter må det lages en glidebane med en håndfil for endodonti. Lag åpningen så rett som mulig for å unngå at filen vrir seg. Bruk en lett bevegelse av typen berør/trekk tilbake uten å forhaste deg. Inspiser filen ofte med tanke på tegn på slitasje. Bytt heller filen for tidlig enn for sent.





Endodontic retreatment

The instruments allow for efficient retreatment of the root canals. They are used to gain access to broken instruments or files inside a root canal and to remove them. They are also used for removal of crowns.

Instrument RT1

Conically-shaped and diamond-coated instrument for the location of root canal entry and removal of calcifications in the first coronal third of the root canal system.

Instrument RT2

Thin diamond-coated instrument for removing shoulders and other obstacles as well as for creating a straight canal to access a broken file.

Instruments RT3 (on file holder)

Long and thin instruments for removing of broken file parts from the root canal.

 Use the ESI file to finish the root canal following the removal of the broken file.

Instrument H

Long instrument for the lateral condensation of gutta-percha in the root canals. The heat generated by the high frequencies on the instrument tip softens the gutta-percha and maximizes lateral flow through the root canal system.

Instrument D

Instrument for transmitting ultrasonic vibrations to loosen the cement that attach crowns and bridges to the tooth.

Ponovni endodontski tretman

Instrumenti omogućuju učinkovito ponovno tretiranje korijenskih kanala. Koriste se za pristup slomljenim instrumentima ili iglama unutar korijenskog kanala i za njihovo uklanjanje. Također se koriste za uklanjanje krunica.

Instrument RT1

Instrument u obliku konusa i dijamantno presvučen za lociranje ulaza u korijenski kanal i uklanjanje kalcifikata u prvj koronalnoj trećini sustava korijenskih kanala.

Instrument RT2

Dijamantno presvučen instrument za uklanjanje krivina i drugih prepreka kao i za kreiranje ravnog kanala za pristup slomljenoj igli.

Instrumenti RT3 (na držaču za igle)

Dugi i tanki instrumenti za uklanjanje dijelova slomljene igle iz korijenskog kanala.

 Koristite ESI iglu za završavanje korijenskog kanala nakon uklanjanja slomljene igle.

Instrument H

Dugi instrument za lateralnu kondenzaciju gutaperke u korijenskim kanalima. Toplina koju generiraju visoke frekvencije na vrhu instrumentu omekšavaju gutaperku i maksimiziraju bočni tijek kroz sustav korijenskog kanala.

Instrument D

Instrument za prijenos ultrazvučnih vibracija kako bi se otpustio cement koji pričvršćuje krune i mostove na zub.

Endodontische herbehandeling

De instrumenten maken efficiënte herbehandeling van de wortelkanalen mogelijk. Ze worden gebruikt om toegang te krijgen tot afgebroken instrumenten of vijlen in een wortelkanaal en voor het verwijderen hiervan. Ze worden daarnaast gebruikt voor het verwijderen van kronen.

Instrument RT1

Kegelvormig diamantinstrument voor de lokalisatie van de ingang van een wortelkanaal en voor verwijdering van kalkafzettingen in het eerste coronale derde deel van het wortelkanaalsysteem.

Instrument RT2

Dun diamantinstrument voor het verwijderen van schouders en andere obstakels en voor het creëren van een recht kanaal voor toegang tot een afgebroken vijl.

Instrument RT3 (op vijlhouder)

Lange en dunne instrumenten voor het verwijderen van afgebroken vijldelen uit het wortelkanaal.

 Gebruik de ESI-vijl voor het fineren van het wortelkanaal na verwijdering van de afgebroken vijl.

Instrument H

Lang instrument voor de laterale condensatie van gutta percha in de wortelkanalen. De warmte gegenereerd door de hoge frequenties op de instrumenttip maken de gutta percha zacht zodat deze optimaal zijwaarts door het wortelkanaalsysteem vloeit.

Instrument D

Instrument voor het overbrengen van ultrasone trillingen om het cement los te maken waarmee kronen en bruggen op het gebitselement zijn bevestigd.



Retratamento endodôntico

Os instrumentos permitem o retratamento eficiente dos canais radiculares. São usados para aceder a instrumentos ou limas quebradas no interior de um canal radicular e para os remover. São ainda usados para a remoção de coroas.

Instrumento RT1

Instrumento diamantado com forma cônica para a localização da entrada do canal radicular e remoção de calcificações no primeiro terço coronal do sistema do canal radicular.

Instrumento RT2

Instrumento diamantado fino para a remoção de rebordos e outros obstáculos bem como para criar um canal recto para aceder a uma lima quebrada.

Instrumento RT3 (no porta-limas)

Instrumentos compridos e finos para remoção de pedaços de lima quebrada do canal radicular.

 Use a lima ESI para finalizar o canal radicular após a remoção da lima quebrada.

Instrumento H

Instrumento comprido para a condensação lateral de gutta-percha nos canais radiculares. O calor gerado pelas elevadas frequências na ponta do instrumento amolece a gutta-percha e maximiza o fluxo lateral através do sistema do canal radicular.

Instrumento D

Instrumento para transmitir vibrações ultrassónicas destinadas a libertar o cimento que fixa coroas e pontes ao dente.

Endodontisk genbehandling

Instrumenterne muliggør effektiv genbehandling af rodkanalerne. De anvendes til at få adgang til knækkede instrumenter eller filer i en rodkanal og til at fjerne dem. De bruges også til at fjerne kroner.

Instrument RT1

Koniskformet og diamantbelagt instrument til at lokalisere indgangen til rodkanalen og fjerne tandsten i den første koronale tredjedel af rodkanalsystemet.

Instrument RT2

Tyndt diamantbelagt instrument til at fjerne fremspring og andre hindringer lige så vel som til at oprette en lige kanal til at give adgang til en knækket fil.

Instrumenter RT3 (på filholder)

Lange og tynde instrumenter til at fjerne knækkede fildeler fra rodkanalen.

 Brug ESI-filen til at færdiggøre rodkanalen efter fjernelse af den knækkede fil.

Instrument H

Langt instrument til lateral kondensering af gutta-percha i rodkanalerne. Varmen, der genereres af de høje frekvenser i instrumentspidsen, blødgør gutta-percha'en og maksimerer lateral gennemstrømning i rodkanalsystemet.

Instrument D

Instrument til at overføre ultralydsvibrationer til at løsne cementen, der binder kroner og broer til tænderne.

Endodontisk revisjonsbehandling

Instrumentene muliggør effektiv revisjonsbehandling av rotkanalene. De brukes for å få tilgang til og fjerne brukne instrumenter eller filer inne i en rotkanal. De brukes også til fjerning av kroner.

Instrument RT1

Konisk, diamantbelagt instrument til lokalisering av inngangen til rotkanalen og fjerning av forkalkninger i den første koronale tredjedelen av rotkanalsystemet.

Instrument RT2

Tyndt diamantbelagt instrument til fjerning av utspring og andre hindre samt til å lage en rett kanal for å få tilgang til en brukket fil.

Instrument RT3 (i filholder)

Lange og tynne instrumenter til fjerning av brukne fildeler fra rotkanalen.

 Bruk ESI-filen til å gjøre ferdig rotkanalen etter at den brukne filen er fjernet.

Instrument H

Langt instrument til lateral kondensering av guttaperka i rotkanalene. Varmen som genereres av de høye frekvensene på instrumentspissen, mykner opp guttaperka og maksimerer den laterale strømmen gjennom rotkanalsystemet.

Instrument D

Instrument til overføring av ultralydvibrasjoner for å løsne sement som er brukt til festing av kroner og broer til tannen.





Retrograde endodontics

The retro instruments are used for the retrograde preparation of root canals. They are designed for minimally invasive and efficient treatment.

Retrograde instrument Berutti (on file holder)

Diamond-coated instrument for retrograde preparation of the root canal allowing for cutting inside the tooth structure with a low power setting. A 120° or a 180° file holder can be used.

Retrograde instrument RE2 (120° or 180° file holder)

Instrument thinner than an instrument Berutti for the retrograde preparation of isthmus between the root canals. The surface of the tip is titanium nitride coated for optimal abrasion and precise cutting.

Retrogradna endodoncija

Retrogradni instrumenti koriste se za retrogradnu pripremu korijenskih kanala. Osmišljeni su za minimalno invazivni i učinkovit tretman.

Retrogradni Berutti instrument (na držaču za igle)

Dijamantno presvučen instrument za retrogradnu pripremu korijenskog kanala koja omogućuje rezanje unutar zubne strukture s nižim postavkama energije. Može se koristiti držač za igle od 120° ili 180°.

Retrogradni instrument RE2 (120° ili 180° držač za igle)

Instrument koji je tanji od Berutti instrumenta za retrogradnu pripremu suženja između korijenskih kanala. Površina na vrhu je presvučena titan nitridom za optimalnu abraziju i precizno rezanje.

Retrograde endodontie

De retro-instrumenten worden gebruikt voor de retrograde preparatie van wortelkanalen. Ze zijn ontworpen voor minimaal invasieve en efficiënte behandeling.

Retrograad instrument Berutti (op vijlhouder)

Diamantinstrument voor retrograde preparatie van het wortelkanaal waarmee binnen de tandstructuur met een laag vermogen weefsel kan worden weggenomen. Er kan een 120° of een 180° vijlhouder worden gebruikt.

Retrograad instrument RE2 (120° of 180° vijlhouder)

Instrument dat dunner is dan een Berutti-instrument voor retrograde preparatie van de isthmus tussen de wortelkanalen. Het oppervlak van de tip is gecoat met titaannitride voor optimaal slijpen en nauwkeurig wegnemen.



Endodontia retrógrada

Os instrumentos retrógrados são usados para a preparação retrógrada de canais radiculares. São concebidos para um tratamento eficiente e minimamente invasivo.

Instrumento retrógrado Berutti (no porta-limas)

Instrumento diamantado para preparação retrógrada do canal radicular, permitindo o corte dentro da estrutura do dente com um ajuste de potência baixa. Pode ser usado um porta-limas de 120° ou 180°.

Instrumento retrógrado RE2 (porta-limas de 120° ou 180°)

Instrumento mais fino que um instrumento Berutti para preparação retrógrada do istmo entre canais radiculares. A superfície da ponta é revestida com nitreto de titânio para uma abrasão ótima e um corte preciso.

Retrograd endodonti

Retroinstrumenterne anvendes til retrograd præparation af rodkanalerne. De er designet til minimalt invasiv og effektiv behandling.

Retrogradt Berutti-instrument (på filholder)

Diamantbelagt instrument til retrograd præparation af rodkanalen, der muliggør skæring inden i tandstrukturen ved en lav effektindstilling. Der kan anvendes en 120° eller en 180° filholder.

Retrogradt instrument RE2 (120° eller 180° filholder)

Instrument, der er tyndere end et Berutti-instrument, til retrograd præparation af isthmus mellem rodkanalerne. Overfladen på spidsen er belagt med titaniumnitrid for at optimere slibning og præcis skæring.

Retrograd endodonti

Retroinstrumentene brukes til retrograd preparering av rotkanalene. De er utformet for en effektiv og minimalt invasiv behandling.

Retrogradt instrument Berutti (i filholder)

Diamantbelagt instrument til retrograd preparering av rotkanalen som gjør det mulig å skjære på innsiden av tannstrukturen med lav effekt. En 120° eller 180° filholder kan brukes.

Retrogradt instrument RE2 (120° eller 180° filholder)

Instrument som er tynnere enn et Berutti-instrument, til retrograd preparering av isthmus mellom rotkanalene. Spissens overflate er belagt med titannitrid for optimal abrasjon og presis skjæring.



K-type files

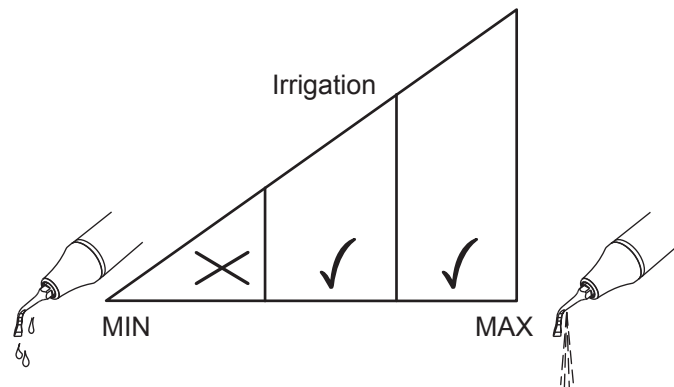
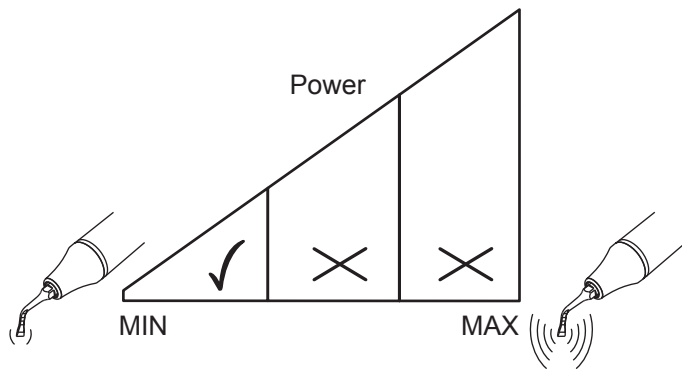
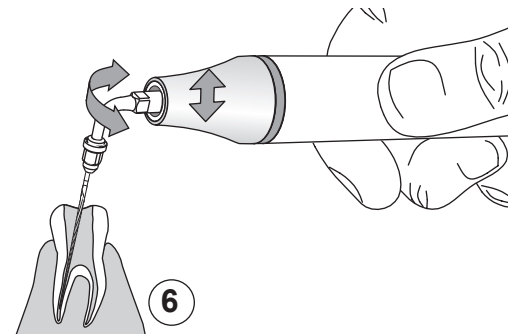
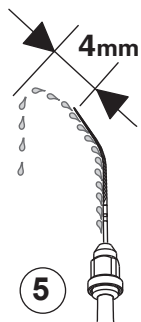
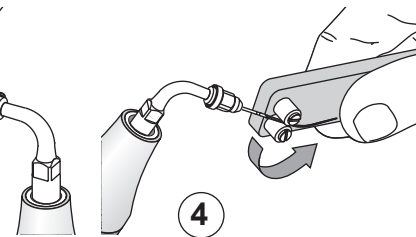
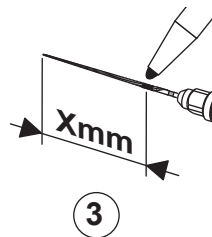
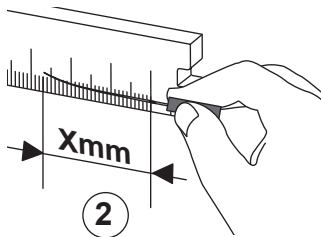
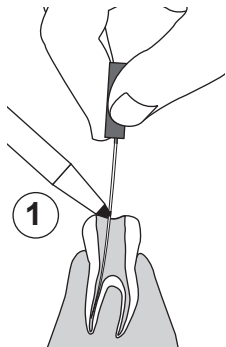
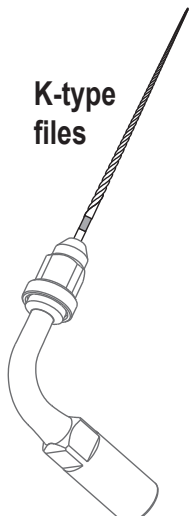





K-type cleaning files (ISO 15 - 35)

Files made of stainless steel for the preparation, cleaning and disinfection of the root canal system. Must be used with a file holder.

Use Endo mode (if available) with a low power setting (maximum 30%), and use a medium to high irrigation flow rate.

 Activate the file for 4 seconds. Do not exceed 10 continuous seconds.

 To set the flow rate, activate both the irrigation and the ultrasound with the tip pointing upwards. The spray must extend by 4 mm the file tip.

 The root canal must be prepared using hand files in size ISO 15 before using the K-type files. Preform the file to the canal morphology if needed. Use slow circular and up-and-down movements and use the "step-back" technique.

Limas de limpeza do tipo K (ISO 15 - 35)

Limas em aço inoxidável para a preparação, limpeza e desinfecção do sistema de canal radicular. Têm de ser usadas com um porta-limas.

Use um ajuste de potência baixa, em modo ENDO se disponível (máximo de 30%) e um caudal de irrigação médio a elevado.

 Active a lima durante 4 segundos. Não ultrapasse os 10 segundos contínuos.

 Para ajustar o caudal, active a irrigação e os ultrassons com a ponta voltada para cima. A pulverização tem de se ultrapassar em 4 mm a ponta da lima.

 O canal radicular tem de ser preparado com limas manuais de tamanho ISO 15, antes de usar as limas tipo K. Conforme a lima à morfologia do canal, se necessário. Use movimentos lentos circulares e ascendentes-descendentes e use a técnica "step-back".

Igla za čišćenje K tipa (ISO 15 - 35)

Igla načinjena od nerđajućeg čelika za pripremu, čišćenje i dezinfekciju. Mora se koristiti s držačem za iglu.

Koristite Endo način rada (ako postoji) s niskim postavkama energije (maksimalno 30%), i koristite srednji do visoki stupanj tijeka ispiranja.

 Aktivirajte iglu tijekom 4 sekunde. Nemojte premašiti 10 neprekidnih sekundi.

 Kako biste podesili brzinu tijekom, aktivirajte ispiranje i ultrazvuk tako da vrh uperite uvis. Raspršivanje mora za 4 mm premašivati vrh igle.

 Korijenski kanal mora se pripremiti pomoću ručnih igli veličine ISO 15 prije uporabe igala tipa K. Ako treba, iglu prilagodite morfologiji kanala. Koristite spore kružne pokrete gore-dolje i koristite tehniku "step-back".

K-rensningsfiler (ISO/15 35)

Filer, der er fremstillet af rustfrit stål til præparation, rensning og desinficering af rodkanalsystemet. Skal anvendes sammen med en filholder.

Brug Endo-funktionen (hvis den er tilgængelig) med lav effektindstilling (maks. 30 %) og brug en skyllegennemstrømning, der er middel til høj.

 Aktiver filen i 4 sekunder, men ikke i mere end 10 fortløbende sekunder.

 Indstil gennemstrømningshastigheden ved at aktivere både skylningen og ultralyden med spidsen pegende opad. Strålen skal være 4 mm længere end filspidsen.

 Rodkanalen skal præpareres med håndfiler i størrelse ISO 15, før K-filerne anvendes. Form filen efter kanalen, hvis det er nødvendigt. Brug langsomme cirkulære og op- og nedadgående bevægelser og "step-back" teknik.

K-vijlen voor reiniging (ISO nr. 15 - 35)

Vijlen van roestvrij staal voor de preparatie, reiniging en desinfectie van het wortelkanaalsysteem. Moeten worden gebruikt met een vijlhouder.

Gebruik de Endo-modus (indien beschikbaar) met de laagst mogelijke vermogensinstelling (maximaal 30%) en gebruik een middelhoge tot hoge irrigatiestroom.

 Activeer de vijl gedurende 4 seconden. Niet langer dan 10 seconden achtereenvolgende activeren.

 Activeer zowel de irrigatie als het ultrageluid met de tip naar boven gericht om de irrigatiestroom in te stellen. De spray moet 4 mm verder komen dan de vijltip.

 Het wortelkanaal moet worden geprepareerd met handvijlen maat ISO nr. 15 vóór de K-vijlen worden gebruikt. Zo nodig kunt u de vorm van tevoren aan de vijl aan de morfologie van het kanaal aanpassen. Gebruik langzaam ronddraaiende en op-en-neergaande bewegingen en pas de step-backtechniek toe.

K-filer til rengjøring (ISO 15 - 35)

Filer av rustfritt stål til preparering, rengjøring og desinfisering av rotkanalsystemet. Må brukes med filholder.

Bruk endomodus (hvis den er tilgjengelig) med en lav effektinnstilling (maks. 30 %), og bruk medium til høy irrigasjonsstrøm.

 Aktiver filen i 4 sekunder. Må ikke aktiveres i mer enn 10 etterfølgende sekunder.

 Strømningshastigheten innstilles ved å aktivere både irrigasjonen og ultralyden med spissen pekende opp. Strålen skal være 4 mm lengre enn filens spiss.

 Rotkanalen må prepareres ved hjelp av håndfiler i størrelse ISO 15 før K-filerne brukes. Form filen etter kanalens morfologi ved behov. Bruk langsomme, sirkulære opp/ned-bevegelser og bruk "step-back"-teknikken.

ENDO



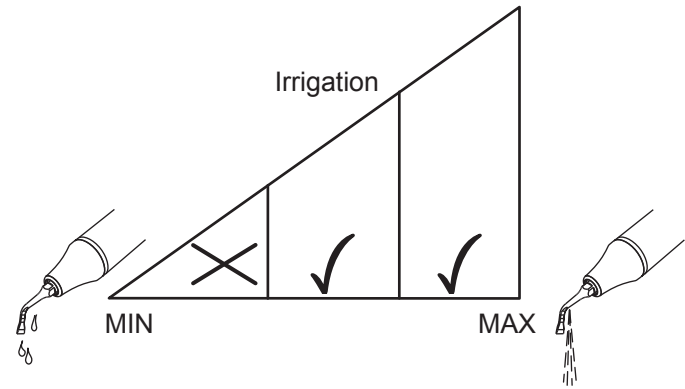
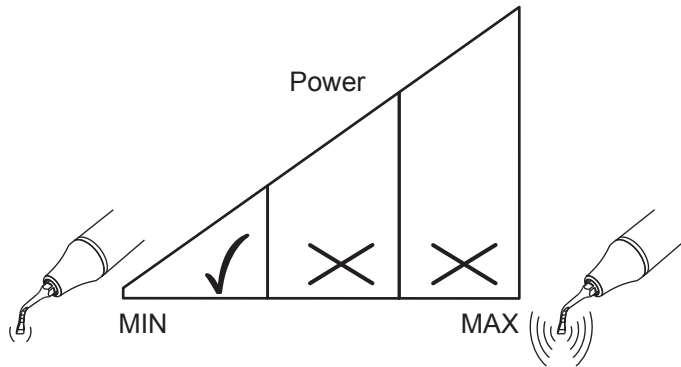
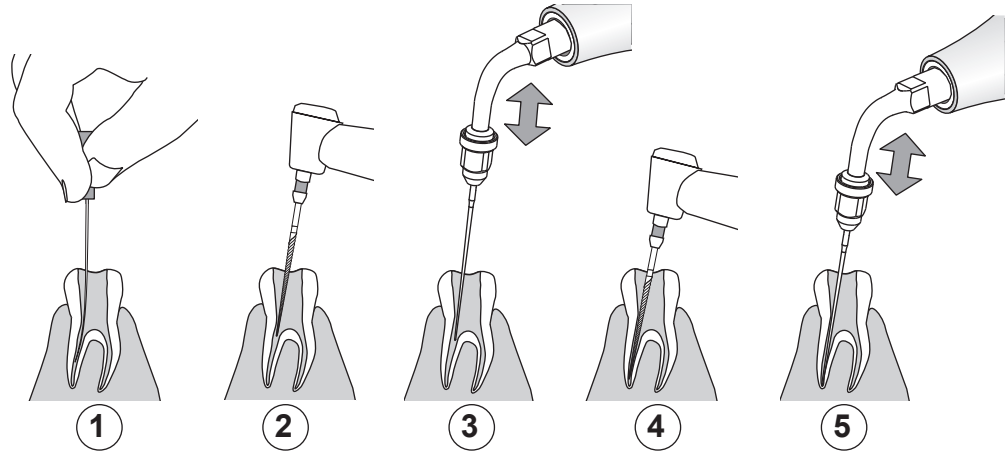
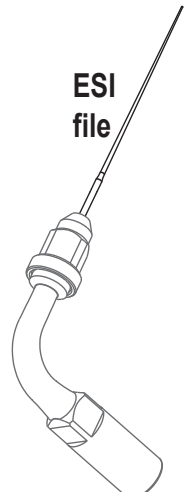





Endo soft instrument ESI (ISO 15)

Smooth non-cutting file made of nickel titanium alloy (NiTi) for cleaning and irrigation of the root canal system. Must be used with a file holder.

Use Endo mode (if available) with a low power setting (maximum 30%), and use a medium to high irrigation flow rate.

 The ESI files can be used for a maximum of fifteen straight root canals, but for one single root canal when it is curved.

 The root canal must be prepared using hand files in size ISO 15 before using the ESI file. The ESI file will be used in sequence with a rotating or manual shaping system.

 Activate the ESI file for an approximate maximum of 3 x 20 seconds with high irrigation for each canal. Use gentle up-and-down movements to irrigate the root canal.

Instrumento endo soft ESI (ISO 15)

Lima lisa e não cortante em liga de níquel-titânio (NiTi) para limpeza e irrigação do sistema do canal radicular. Tem de ser usada com um porta-limas.

Use um ajuste de potência baixa, em modo ENDO se disponível (máximo de 30%) e um caudal de irrigação médio a elevado.

 As limas ESI podem ser usadas para um máximo de quinze canais radiculares retos, mas apenas para um só canal radicular curvo.

 O canal radicular tem de ser preparado com limas manuais de tamanho ISO 15, antes de usar a lima ESI. A lima ESI será usada sequencialmente com um sistema de modelação rotativo ou manual.

 Active a lima ESI por um período máximo aproximado de 3 x 20 segundos com irrigação elevada, para cada canal. Use movimentos ascendentes-descendentes suaves para irrigar o canal radicular.

Endodontski mekani ESI instrument (ISO 15)

Glatka igla koja ne reže proizvedena od legure nikal titana (NiTi) za čišćenje i ispiranje sustava korijenskih kanala. Mora se koristiti s držačem za iglu.

Koristite Endo način rada (ako postoji) s niskim postavkama energije (maksimalno 30%), i koristite srednji do visoki stupanj tijekom ispiranja.

 ESI igle mogu se koristiti za najviše petnaest uzastopnih korijenskih kanala, ali za jedan korijenski kanal ako je on zavijen.

 Korijenski kanal mora biti pripremljen pomoću ručnih igala veličine ISO 15 prije uporabe ESI igle. ESI igla koristi se u nastavku s rotirajućim ili ručnim sustavom za oblikovanje.

 Aktivirajte ESI iglu u potrebnih maksimalno 3 x 20 sekundi s visokim stupnjem ispiranja za svaki kanal. Koristite nježne pokrete gore-dolje kako biste isprali korijenski kanal.

Blødt endoinstrument ESI (ISO/15)

Glat ikke-skærende fil, der er fremstillet af en legering af nikkel og titanium (NiTi) til rensning og skylning af rodkanalsystemet. Skal anvendes sammen med en filholder.

Brug Endo-funktionen (hvis den er tilgængelig) med lav effektindstilling (maks. 30 %) og brug en skyllegenemstrømning, der er middel til høj.

 En ESI-fil kan maksimalt anvendes til femten lige rodkanaler, men kun til én enkelt rodkanal, når den er buet.

 Rodkanalen skal præpareres med håndfiler i størrelse ISO 15, før ESI-filen anvendes. ESI-filen skal anvendes skiftevis sammen med et roterende eller et manuelt formningssystem.

 Aktiver ESI-filen i maksimalt ca. 3 x 20 sekunder med høj skylning af hver kanal. Brug blide op- og nedadgående bevægelser til at skylle rodkanalen.

Endo soft ESI instrument (ISO nr. 15)

Gladde, niet-snijdende vijl van nikkeltitaniumlegering (NiTi) voor reiniging en irrigatie van het wortelkanaal-systeem. Moet worden gebruikt met een vijlhouder.

Gebruik de Endo-modus (indien beschikbaar) met de laagst mogelijke vermogensinstelling (maximaal 30%) en gebruik een middelhoge tot hoge irrigatiestroom.

 De ESI-vijlen kunnen worden gebruikt voor maximaal vijftien rechte wortelkanalen, maar voor slechts één wortelkanaal wanneer het gebogen is.

 Het wortelkanaal moet worden geprepareerd met handvijlen maat ISO nr. 15 vóór de ESI-vijl wordt gebruikt. De ESI-vijl wordt in vervolg op een roterend of handmatig modelleersysteem gebruikt.

 Activeer de ESI-vijl gedurende ongeveer maximaal 3 x 20 seconden met een sterke irrigatie voor elk kanaal. Maak voorzichtige op-en-neergaande bewegingen om het wortelkanaal te irrigeren.

Mykt endoinstrument ESI (ISO 15)

Myk, ikke-skjærende fil av nikkeltitanlegering (NiTi) til rengjøring og irrigasjon av rotkanalsystemet. Må brukes med filholder.

Bruk endomodus (hvis den er tilgjengelig) med en lav effektinnstilling (maks. 30 %), og bruk medium til høy irrigasjonsstrøm.

 ESI-filene kan brukes til høyst 15 rette rotkanaler, men til én rotkanal hvis den er bøyd.

 Rotkanalen må prepareres ved hjelp av håndfiler i størrelse ISO 15 før ESI-filen brukes. ESI-filen brukes i sekvens med et roterende eller manuelt formingssystem.

 Aktiver ESI-filen i cirka 3 x 20 sekunder (maksimalt) med høy irrigasjon for hver kanal. Irriger rotkanalen ved å bruke forsiktige opp/ ned-bevegelser.



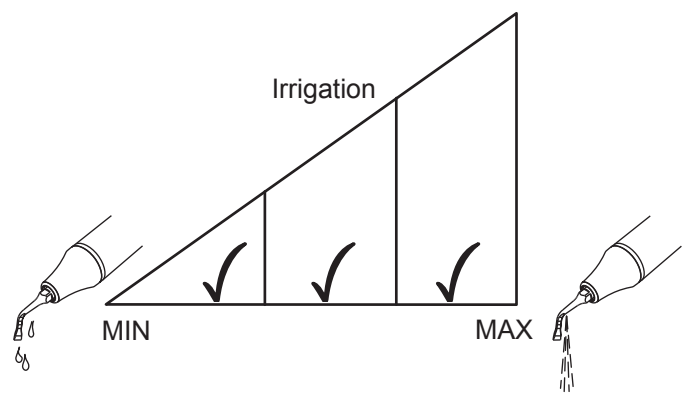
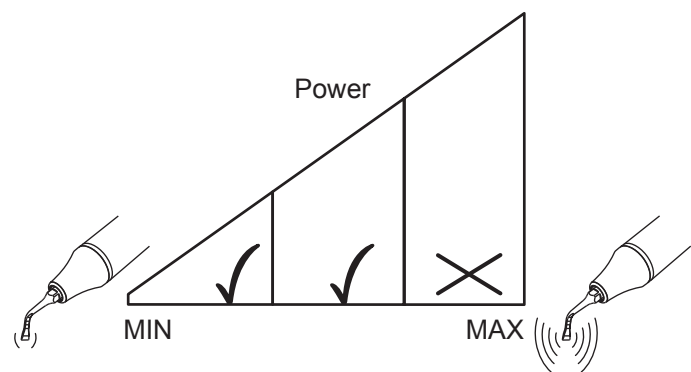
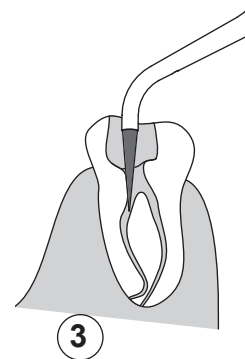
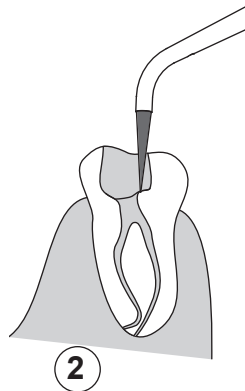
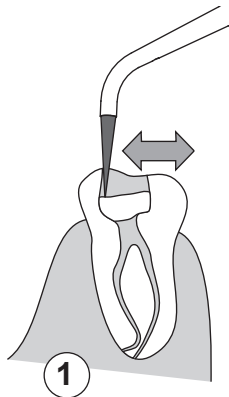
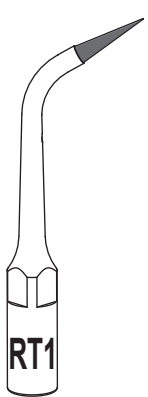



Retreatment instrument RT1

Diamond-coated instrument for location of root canals and removal of calcifications in the coronal third of the root canal system.

Use a low to medium power setting.

Use a low to high irrigation flow rate.

 Remove the calcification without applying pressure.

Instrument za ponovni tretman RT1

Dijamantno presvučeni instrument za lociranje korijenskih kanala i uklanjanje kalcifikacija u koronalnoj trećini sustava korijenskih kanala.

Koristite niske do srednje postavke energije.

Koristite nisku do visoku razinu mlaza za ispiranje.

 Uklonite kalcifikaciju bez primjene pritiska.

Instrument RT1 voor herbehandeling

Diamantinstrument voor de lokalisatie van wortelkanalen en verwijdering van kalkafzettingen in het coronale derde deel van het wortelkanaalsysteem.

Gebruik een laag tot middelhoog vermogen.

Gebruik een lage tot hoge irrigatiestroom.

 Verwijder de kalkafzetting zonder druk uit te oefenen.

Instrumento de retratamento RT1

Instrumento diamantado para a localização de canais radiculares e remoção de calcificações no terço coronal do sistema do canal radicular.

Use um ajuste de potência baixa a média.

Use um caudal de irrigação baixo a elevado.

 Retire a calcificação sem aplicar pressão.

Genbehandlingsinstrument RT1

Diamantbelagt instrument til at lokalisere rodkanalerne og fjerne tandsten i den koronale tredjedel af rodkanalsystemet.

Anvend en lav til middel effektindstilling.

Anvend en lav til høj hastighed for skyllegennemstrømningen.

 Fjern tandstenen uden at påføre tryk.

Revisjonsinstrument RT1

Diamantbelagt instrument til lokalisering av rotkanaler og fjerning av forkalkninger i den koronale tredjedelen av rotkanalsystemet.

Bruk lav til middels effekt.

Bruk lav til høy irrigasjonsstrøm.

 Fjern forkalkningen uten å bruke trykk.



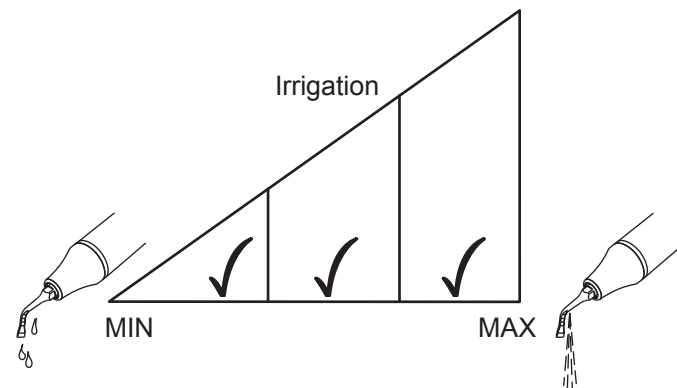
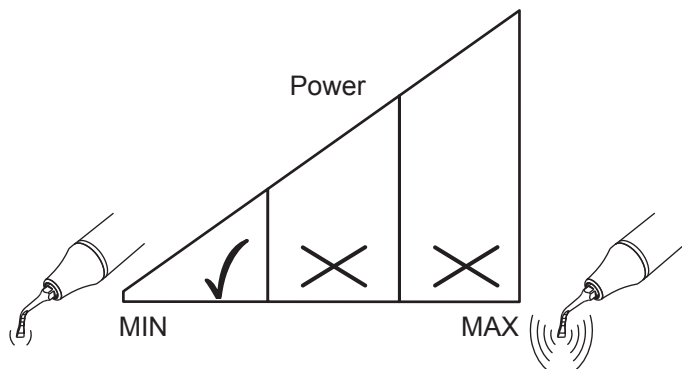
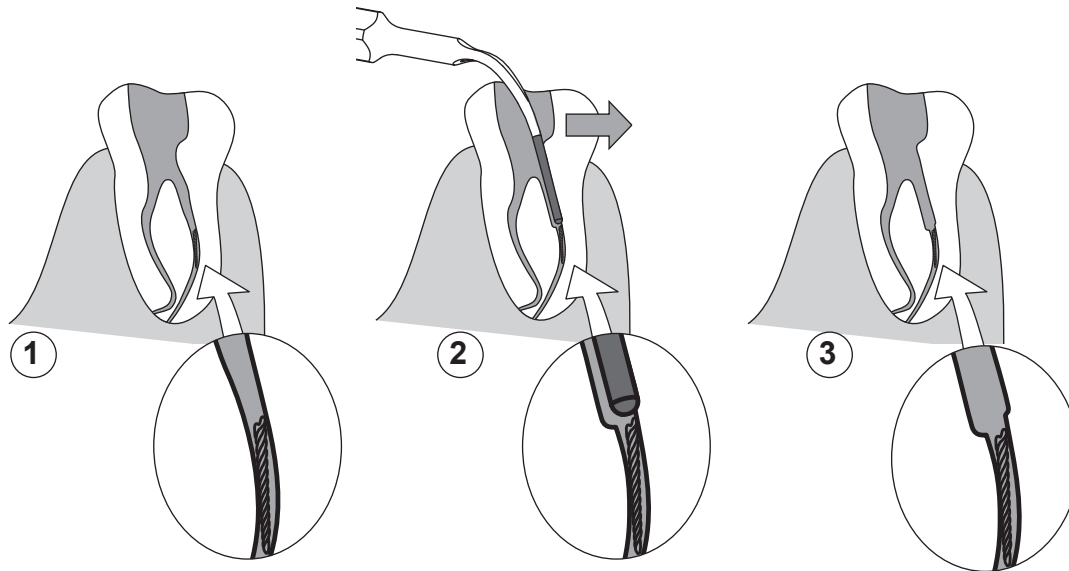
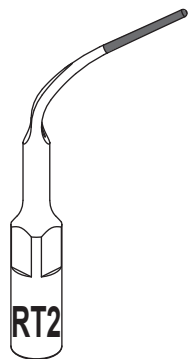



Retreatment instrument RT2

Diamond-coated instrument for removal of ledges and access to files broken in the root canal.

Use a low power setting.

Use a low to high irrigation flow rate.

 Do not make contact between instrument and broken file to not push it deeper. Do not apply pressure to the instrument in the axial direction.

Instrument za ponovni tretman RT2

Dijamantno presvučeni instrument za uklanjanje izbočina i pristupa iglama koje su se slomile u korijenskom kanalu.

Koristite niske postavke energije

Koristite nisku do visoku razinu mlaza za ispiranje.

 Neka ne bude kontakta između instrumenta i slomljene igle kako je ne biste gurnuli dublje. Ne primjenjujte pritisak na instrument u aksijalnom smjeru.

Instrument RT2 voor herbehandeling

Diamantinstrument voor de verwijdering van ledges en voor toegang tot vijlen die in het wortelkanaal zijn afgebroken.

Gebruik een laag vermogen.

Gebruik een lage tot hoge irrigatiestroom.

 Vermijd contact tussen instrument en afgebroken vijl om deze niet verder te duwen. Oefen op het instrument geen druk in axiale richting uit.

ENDO



Instrumento de retratamento RT2

Instrumento diamantado para a remoção de rebordos e acesso a limas quebradas no canal radicular.

Use um ajuste de potência baixa.

Use um caudal de irrigação baixo a elevado.

 Não coloque em contacto o instrumento com a lima quebrada para não a empurrar mais para baixo. Não aplique pressão sobre o instrumento na direcção axial.

Genbehandlingsinstrument RT2

Diamantbelagt instrument til fjernelse af kanter og adgang til filer, der er knækket i rodkanalen.

Anvend en lav effektindstilling.

Anvend en lav til høj hastighed for skyllegennemstrømningen.

 Berør ikke den knækkede fil med instrumentet for ikke at skubbe den dybere ned. Påfør ikke tryk på instrumentet i aksial retning.

Revisjonsinstrument RT2

Diamantbelagt instrument til fjerning av utstikkende lister og for å få tilgang til brukne filer i rotkanalen.

Bruk lav effekt.

Bruk lav til høy irrigasjonsstrøm.

 Instrumentet må ikke komme i kontakt med den brukne filen, det kan føre til at filen trykkes lengre inn. Ikke trykk instrumentet i aksial retning.



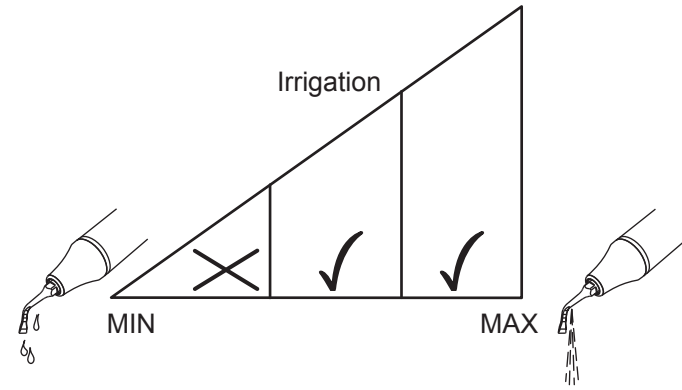
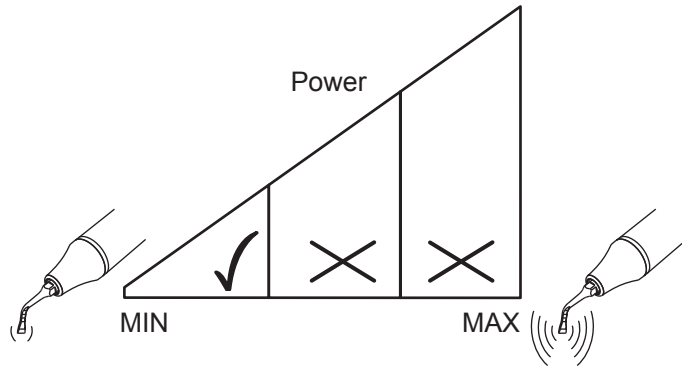
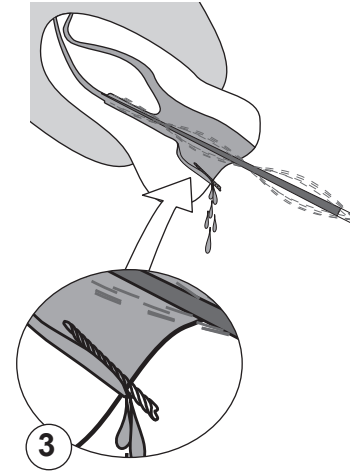
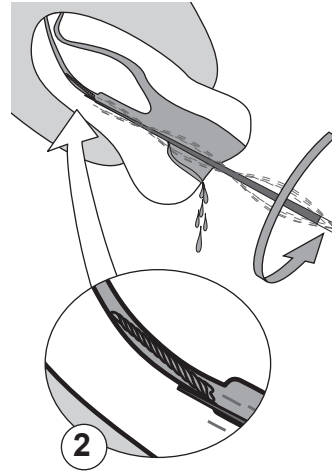
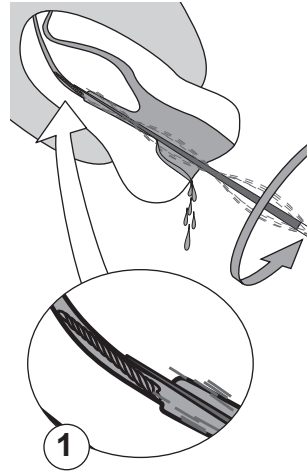
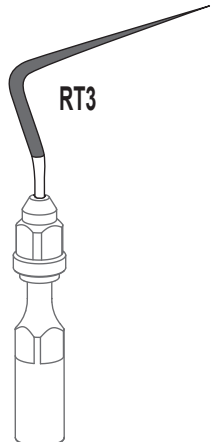



Retreatment instrument RT3

Instrument for the removal of files broken inside a root canal. Must be used with a file holder.

Use a low power setting

Use a medium to high flow rate.

If possible place the patient head in a position where the root canal is horizontal with a downward inclination. Rotate the tip of the instrument counterclockwise around the broken part until it is free from the root canal.

The combined effect of irrigation flow and gravity enables the extraction of the broken file and debris from the root canal.

 Avoid contact between instrument and broken file to not push it deeper. Do not apply pressure to the instrument in the axial direction.

Instrumento de retratamento RT3

Instrumento para a remoção de limas quebradas no interior de um canal radicular. Tem de ser usado com um porta-limas.

Use um ajuste de potência baixa.

Use um caudal médio a elevado.

Se possível, coloque a cabeça do paciente numa posição em que o canal radicular fique horizontal com uma inclinação descendente. Rode a ponta do instrumento para a esquerda em redor da peça quebrada até a libertar do canal radicular.

O efeito combinado de fluxo de irrigação e gravidade permite a extracção da lima quebrada e dos resíduos do canal radicular.

 Evite o contacto entre o instrumento e a lima quebrada para não a empurrar mais para baixo. Não aplique pressão sobre o instrumento na direcção axial.

Instrument za ponovni tretman RT3

Instrument za uklanjanje iglica slomljenih u korijenskom kanalu. Mora se koristiti s držačem za iglu.

Koristite visoke postavke energije.

Koristite visoku do srednju razinu mlaza.

Ako je moguće, postavite glavu pacijenta u položaj u kojem je korijenski kanal vodoravan s nagibom prema dolje. Okrenite vrh instrumenta u smjeru suprotnom od smjera kazaljke na satu oko slomljenog dijela sve dok ga ne oslobodite iz korijenskog kanala.

Kombinirani učinak mlaza ispiranja i gravitacije omogućuje vađenje slomljene igle i krhotina iz korijenskog kanala.

 Izbjegavajte kontakt između instrumenta i slomljene igle kako je ne biste gurnuli dublje. Ne primjenjujte pritisak na instrument u aksijalnom smjeru.

Genbehandlingsinstrument RT3

Instrument til fjernelse af knækkede filer i en rodkanal. Skal anvendes sammen med en filholder.

Anvend en lav effektindstilling.

Anvend en middel til høj gennemstrømningshastighed.

Anbring, hvis det er muligt, patientens hoved i en position, hvor rodkanalen er vandret med en nedadgående hældning. Drej instrumentspidsen mod uret omkring den knækkede del, indtil den er fri af rodkanalen.

Den kombinerede virkning af skyllegennemstrømningen og tyngdekraften gør det muligt at trække den knækkede fil og debris ud af rodkanalen.

 Undgå at berøre den knækkede fil med instrumentet for ikke at skubbe den dybere ned. Påfør ikke tryk på instrumentet i aksial retning.

Instrument RT3 voor herbehandeling

Instrument voor de verwijdering van vijlen die in het wortelkanaal zijn afgebroken. Moet worden gebruikt met een vijlhouder.

Gebruik een laag vermogen

Gebruik een middelhoge tot hoge irrigatiestroom.

Plaats het hoofd van de patiënt zo mogelijk in een positie waarbij het wortelkanaal horizontaal ligt en de onderste wand schuin naar beneden wijst. Roteer de tip van het instrument tegen de wijzers van de klok in rond het afgebroken deel tot dit vrij ligt van het wortelkanaal.

Het gecombineerde effect van irrigatiestroom en zwaartekracht maakt de verwijdering van de afgebroken vijl en deeltjes uit het wortelkanaal mogelijk.

 Vermijd contact tussen instrument en afgebroken vijl om deze niet verder te duwen. Oefen op het instrument geen druk in axiale richting uit.

Revisjonsinstrument RT3

Instrument til fjerning av filer som har brukket inne i en rotkanal. Må brukes med filholder.

Bruk lav effekt.

Bruk middels til høy strømningshastighet.

Hvis det er mulig, plasseres pasientens hode slik at rotkanalen ligger horisontalt og heller nedover. Roter instrumentspissen mot urviserne rundt den brukne delen til den løsner fra rotkanalen.

Kombinasjonen av irrigasjonsstrøm og tyngdekraft gjør at den brukne filen og eventuelle rester kan trekkes ut av rotkanalen.

 Instrumentet må ikke komme i kontakt med den brukne filen, det kan føre til at filen trykkes lengre inn. Ikke trykk instrumentet i aksial retning.



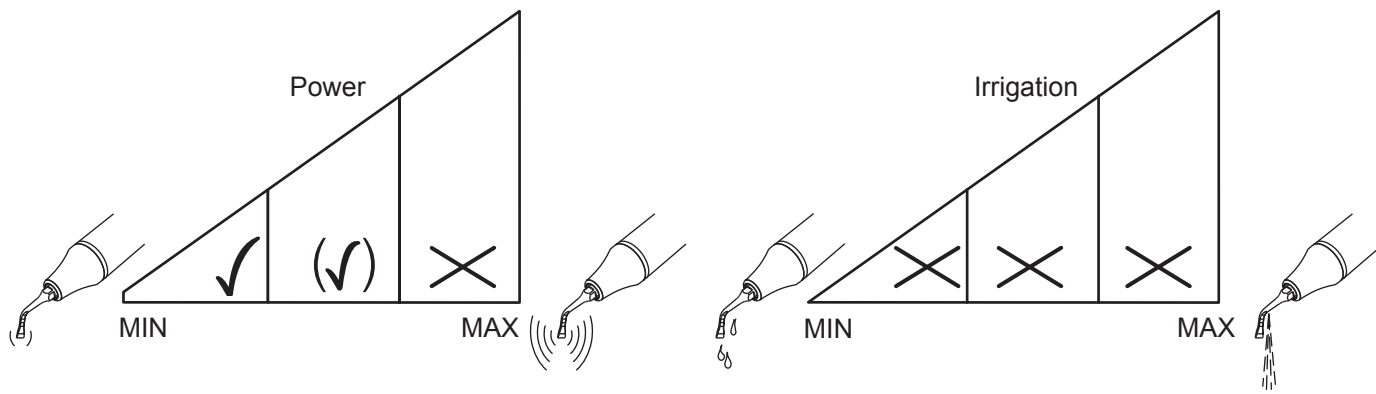
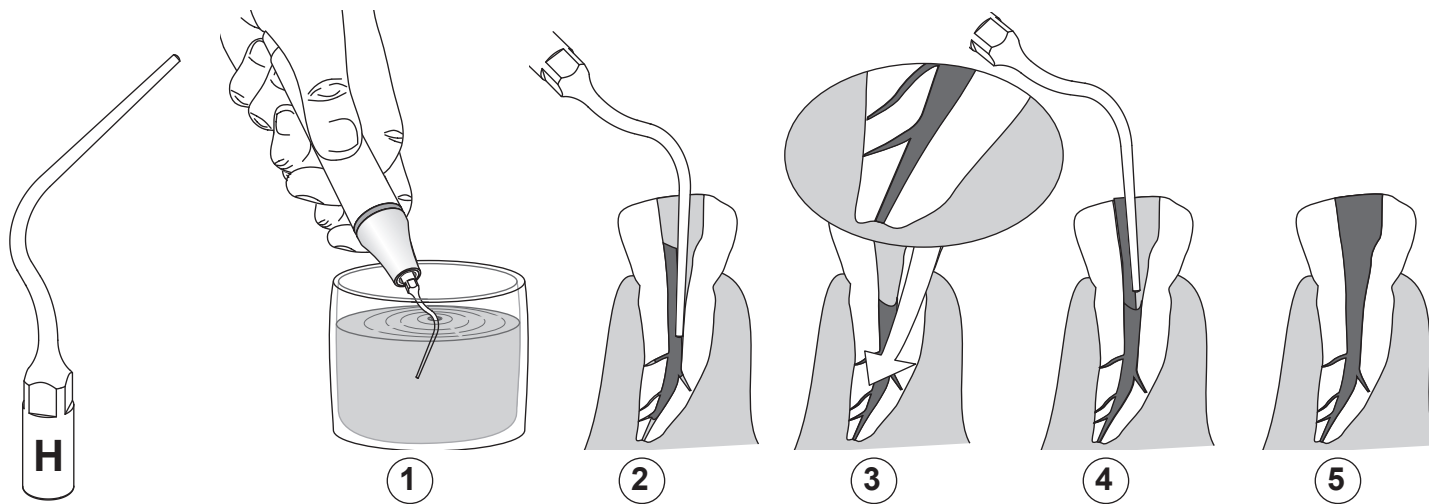



Condensation instrument H

Thermal condensation of gutta-percha.

Use a low to medium power setting and no irrigation.

The heat generated by the ultrasound at the tip of the instrument liquefies the gutta-percha, thus irrigation is not wanted due to its cooling effect.

 Immerse the instrument in eugenol before inserting it in the canal. Slightly press the instrument against the cone of gutta-percha and activate the ultrasound for 2 seconds to condense. Repeat for each inserted cone until the canal is filled.

Kondenzacijski instrument H

Termalna kondenzacija gutaperke.

Koristite niske do srednje postavke energije i ne koristite ispiranje.

Toplina koju stvara ultrazvuk na vrhu instrumenta topi gutaperku pa stoga ispiranje nije poželjno zbog njegovog efekta hlađenja.

 Uronite instrument u eugenol prije nego što ga umetnete u kanal. Lagano pritisnite instrument uz konus gutaperke i aktivirajte ultrazvuk na 2 sekunde radi postizanja kondenzacije. Ponovite za svaki umetnuti konus dok kanal nije napunjen.

Condensatie-instrument H

Thermisch condenseren van gutta percha.

Gebruik een laag tot middelhoog vermogen en geen irrigatie.

De warmte die wordt gegenereerd door het ultrageluid aan de tip van het instrument maakt de gutta percha vloeibaar. In verband met het koelende effect is irrigatie dus niet gewenst.

 Dompel het instrument in eugenol alvorens het in het kanaal in te brengen. Druk het instrument licht tegen de gutta percha-stift en activeer het ultrageluid gedurende 2 seconden om te condenseren. Herhaal dit voor elke ingebrachte stift tot het kanaal is gevuld.

Instrumento de condensação H

Condensação térmica de gutta-percha

Use um ajuste de potência baixa a média, sem irrigação.

O calor gerado pelos ultrassons na ponta do instrumento liquefaz a gutta-percha, não sendo assim desejável a irrigação devido ao seu efeito de arrefecimento.

 Mergulhe o instrumento em eugenol antes de o inserir no canal. Pressione ligeiramente o instrumento contra o cone de gutta-percha e active os ultrassons durante 2 segundos para condensar. Repita a operação para cada cone inserido até o canal ficar preenchido.

Kondenseringsinstrument H

Termisk kondensering af gutta-percha.

Anvend en lav til middel effektindstilling og ingen skylning.

Varmen, der genereres af ultralyden ved instrumentspidsen, gør gutta-percha'en flydende og udelukker derved skylningen på grund af dens afkølede virkning.

 Læg instrumentet i eugenol, før det indføres i kanalen. Tryk instrumentet let mod gutta-percha-keglen og aktiver ultralyden i 2 sekunder for at kondensere. Gentag dette for hver indsat kegle, indtil kanalen er fyldt.

Kondenseringsinstrument H

Varmekondensering av guttaperka.

Bruk lav til middels effekt og ingen irrigasjon.

Varmen som genereres av ultralyden ved spissen av instrumentet, gjør guttaperka flytende, og irrigasjon er derfor ikke ønskelig på grunn av den avkjølede effekten av dette.

 Legg instrumentet i eugenol før det føres inn i kanalen. Trykk instrumentet lett mot guttaperka-konusen og aktiver ultralyden i 2 sekunder for å kondensere. Gjenta dette for hver innlagte konus til kanalen er fylt.

ENDO



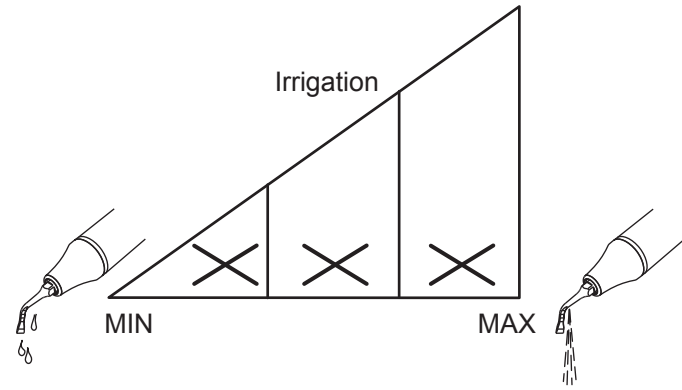
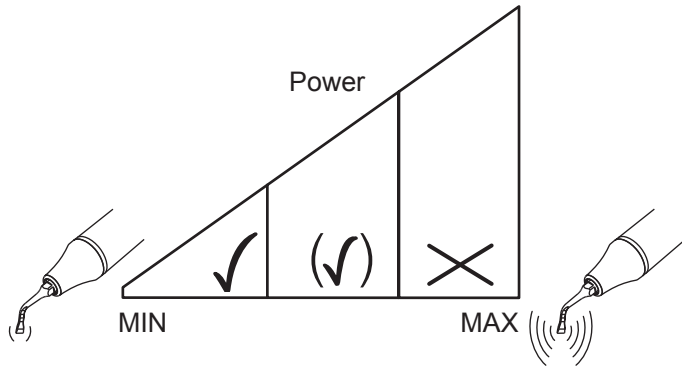
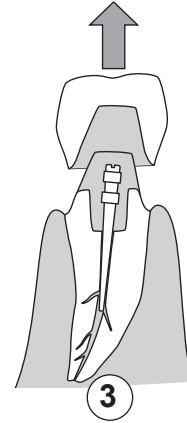
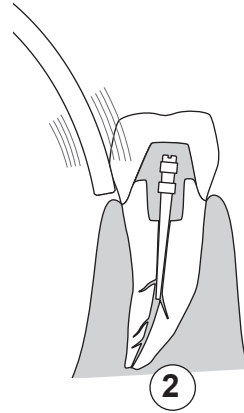
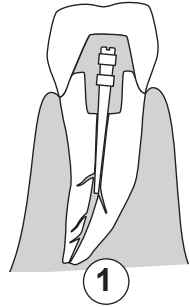



Removal instrument D

Removal of crowns and bridges (works on cements with mechanical or micro-mechanical retention principle; it does not work on adhesive bonded cements).

Use a low power setting and increase as needed. Do not use irrigation.

Apply the instrument onto surface and activate. Increase pressure until vibrations can no longer be heard and maintain for few seconds. An intermittent activation avoids injuring the pulp with heat by allowing time for heat dissipation.

 The instrument D is useful for loosening cementation on hard materials. However the high frequencies of ultrasound applied onto ceramics or composites may eventually fracture them.

Instrumento de remoção D

Remoção de coroas e pontes (funciona com cimentos com princípio de retenção mecânica ou micromecânica; não funciona em cimentos ligados com cola).

Use um ajuste de potência baixa e aumente, conforme necessário. Não utilize irrigação.

Aplique o instrumento à superfície e active. Aumente a pressão até as vibrações deixarem de se ouvir e mantenha por alguns segundos. Uma activação intermitente impede que a pulpa sofra lesões térmicas, dando tempo à dissipação do calor.

 O instrumento D é útil para libertar a cimentação de materiais duros. No entanto, as elevadas frequências de ultrassons aplicadas a material cerâmico ou a compósitos pode fracturá-los.

Instrument za uklanjanje D

Uklanjanje kruna i mostova (učinkovito na cementima s mehaničkim i mikro-mehaničkim principom zadržavanja; nije učinkovito na cementima vezanim lijepljenjem).

Koristite niske ili srednje postavke energije za tvrde naslage zubnog kamenca. Nemojte koristiti ispiranje.

Primijenite instrument na površinu i aktivirajte. Povećajte pritisak sve dok se više ne čuju vibracije i održite ga nekoliko sekundi. Uporaba s prekidima omogućuje izbjegavanje oštećenja na pulpi pomoću topline i omogućuje vrijeme za raspršenje topline.

 Instrument D koristan je za otpuštanje cementa na tvrdim materijalima. Bez obzira na to, visoke frekvencije ultrazvuka koje se primjenjuju na keramiku ili kompozite mogu ih slomiti.

Udtagningsinstrument D

Udtagnung af kroner og broer (fungerer på cement, som holdes på plads på mekanisk eller mikromekanisk vis. Fungerer ikke på klæbende cementer).

Anvend en lav effektindstilling og øg den efter behov. Undlad at anvende skylning.

Før instrumentet hen på fladen og aktiver det. Øg trykket, indtil vibrationerne ikke længere kan høres og fortsæt i nogle få sekunder. En intermitterende aktivering gør, at pulpa ikke bliver skadet af varmen ved at tillade tid til afkøling.

 Instrument D er nyttigt til at løsne cementering på hårde materialer. De høje ultralydsfrekvenser, der påføres på keramiske og kompositmaterialer kan dog til sidst frakturere dem.

Verwijderingsinstrument D

Verwijdering van kronen en bruggen (werkt op cementen met mechanische of micromechanische retentie; het werkt niet met adhesieve cementen).

Gebruik een laag vermogen en voer dit naar behoefte op. Gebruik geen irrigatie.

Houd het instrument tegen het oppervlak en activeer het. Verhoog de druk tot de trillingen niet meer kunnen worden gehoord en houd dit enkele seconden vast. Een intermitterende activering voorkomt letsel aan de pulpa door warmte doordat de warmte zich kan verspreiden.

 Instrument D is zinvol voor het losmaken van cementering op harde materialen. Wanneer de hoge ultrasone frequenties echter op porselein of composieten worden toegepast, kunnen deze hierdoor uiteindelijk breken.

Fjerningsinstrument D

Til fjerning av kroner og broer (fungerer på sement som holdes på plass mekanisk eller mikromekanisk, fungerer ikke med limt sement).

Bruk lav effekt og øk effekten ved behov. Bruk ikke irrigasjon.

Hold instrumentet mot overflaten og aktiver det. Øk trykket til vibrasjonene ikke lenger kan høres, og hold det slik i noen sekunder. Periodisk aktivering gjør at varmen ikke skader pulpen fordi tannen rekker å bli avkjølt mellom hver gang.

 Instrument D er nyttig for å løsne sementering på hardt materiale. I lengden kan ultralydens høye frekvenser imidlertid forårsake sprekker i keramikk og komposittmateriale.

ENDO



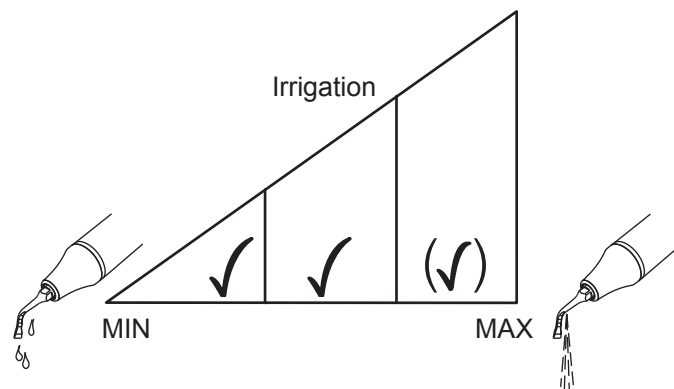
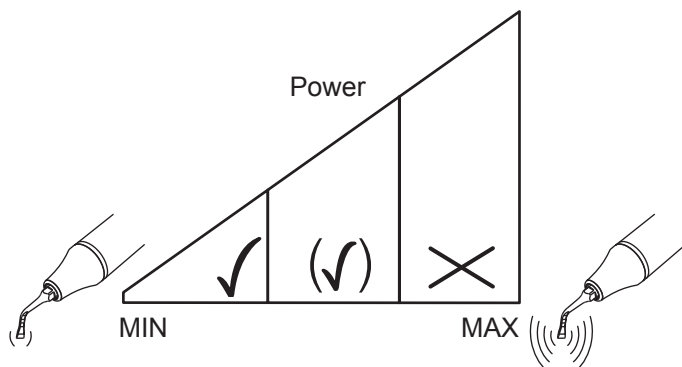
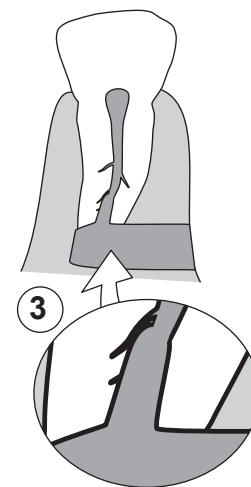
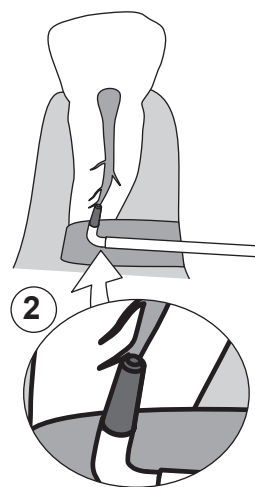
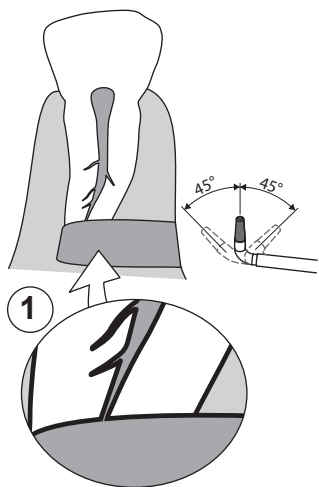
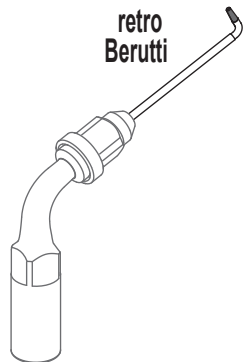





Retrograde instrument Berutti

Diamond-coated instrument for the retrograde preparation of root canals. Must be used with a file holder.

Use a low to medium power.

Use a low to high if suitable irrigation flow rate.

 Keep the cut of root apex and bone cavity as small as possible. The use of retrograde instruments requires much less space than when using conventional files or instruments.

 The retro Berutti instrument can be bent as shown for an easier access to the canal; however, it can only be bent once.

Retrogradni instrument Berutti

Dijamantno presvučeni instrument koristi se za retrogradnu pripremu korijenskih kanala. Mora se koristiti s držačem za iglu.

Koristite niske do srednje postavke energije.

Koristite nisku do visoku razinu mlaza za ispiranje.

 Držite rez apeksa korijena i šupljine kosti koliko je god moguće malim. Uporaba retrogradnih instrumenata zahtijeva mnogo manje prostora nego kod uporabe konvencionalnih igala ili instrumenata.

 Retro instrument Berutti može se saviti kako je prikazano za lakši pristup kanalu; međutim može ga se saviti samo jednom.

Retrograad instrument Berutti

Diamantinstrument voor de retrograde preparatie van wortelkanalen. Moet worden gebruikt met een vijlhouder.

Gebruik een laag tot middelhoog vermogen.

Gebruik een lage tot hoge irrigatiestroom indien geschikt.

 Neem zo min mogelijk weefsel van de wortelpunt en botholte weg. Het gebruik van retrograde instrumenten vraagt veel minder ruimte dan gebruik van conventionele vijlen of instrumenten.

 Het retro Berutti-instrument kan worden gebogen zoals getoond voor een gemakkelijker toegang tot het kanaal; het kan echter slechts eenmaal worden gebogen.

ENDO





Instrumento retrógrado Berutti

Instrumento diamantado para a preparação retrógrada de canais radiculares. Tem de ser usado com um porta-limas.

Use uma potência baixa a média.

Use um caudal de irrigação baixo a elevado, quando adequado.

 Faça com que o corte da raiz apical e da cavidade óssea seja o mais reduzido possível. A utilização de instrumentos retrógrados requer muito menos espaço do que a utilização de instrumentos ou limas convencionais.

 O instrumento retrógrado Berutti pode ser dobrado como se ilustra, para um acesso mais fácil ao canal; no entanto, apenas pode ser dobrado uma vez.

Retrogradt Berutti-instrument

Diamantbelagt instrument til retrograd præparation af rodkanalerne. Skal anvendes sammen med en filholder.

Anvend en lav til middel effekt.

Anvend en lav til høj hastighed for skyllegennemstrømningen, hvis det er passende.

 Sørg for, at incisionen til rodspidsen og knoglekaviteten er så lille som mulig. Brugen af retrograde instrumenter kræver langt mindre plads end brugen af konventionelle filer eller instrumenter.

 Berutti-retroinstrumentet kan bøjes som vist for at give en lettere adgang til kanalen. Det kan dog kun bøjes en gang;

Retrograd instrument Berutti

Diamantbelagt instrument til retrograd preparering av rotkanaler. Må brukes med filholder.

Bruk lav til middels effekt.

Bruk lav til høy irrigasjonsstrøm (hvis dette er egnet).

 Hold snittet i rotens apex og benkaviteten så lite som mulig. Retrograde instrumenter krever mye mindre plass enn konvensjonelle filer eller instrumenter.

 Det retrograde Berutti-instrumentet kan bøyes som illustrasjonen viser, for å få enklere tilgang til rotkanalen. Det kan imidlertid bare bøyes en gang.



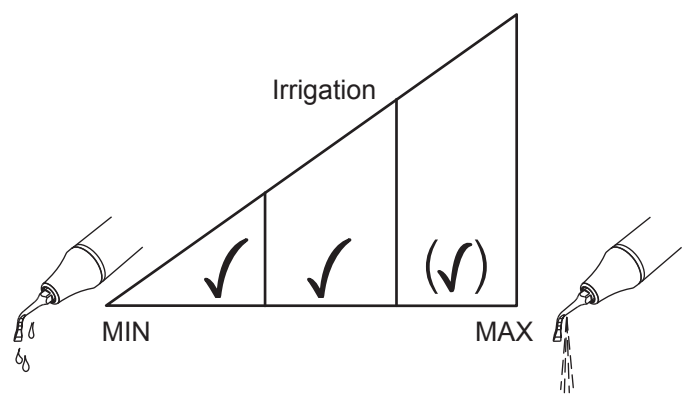
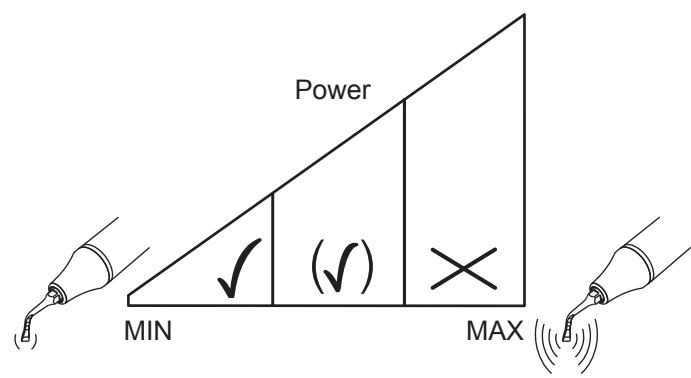
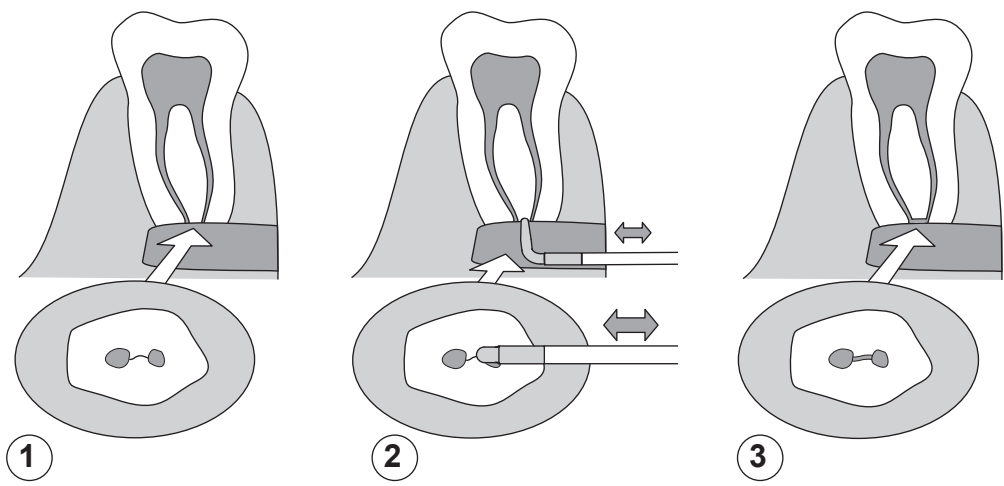
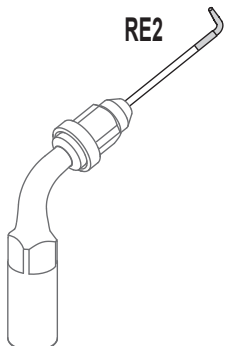





Retrograde instrument for isthmus RE2

Titanium nitride coated instrument for the retrograde preparation of the isthmus between the root canals. Must be used with a file holder.

Use a low to medium power setting.

Use a low to high irrigation rate if suitable.

 Keep the cut of root apex and bone cavity as small as possible. The use of retrograde instruments requires much less space than when using conventional files or instruments.

 Perform a full retrograde canal preparation prior to isthmus preparation. Insert the instrument in one of the two canals where the isthmus begins, then gently move it along the isthmus to create a small groove.

Instrumento retrógrado para istmo RE2

Instrumento revestido com nitreto de titânio para a preparação retrógrada de istmos entre canais radiculares. Tem de ser usado com um porta-limas.

Use um ajuste de potência baixa a média.

Use um caudal de irrigação baixo a elevado, quando adequado.

 Faça com que o corte da raiz apical e da cavidade óssea seja o mais reduzido possível. A utilização de instrumentos retrógrados requer muito menos espaço do que a utilização de instrumentos ou limas convencionais.

 Efectue uma preparação retrógrada completa do canal antes da preparação do istmo. Insira o instrumento num dos dois canais com ligação ao istmo, e desloque-o cuidadosamente ao longo do istmo, de modo a criar um pequeno sulco.

Retrogradni instrument za suženja RE2

Instrument presvučen titan nitridom za retrogradnu pripremu suženja između korijenskih kanala. Mora se koristiti s držačem za iglu.

Koristite niske do srednje postavke energije.

Koristite nisku do visoku razinu mlaza za ispiranje, ako je prikladno.

 Držite rez apeksa korijena i šupljine kosti koliko je god moguće malim. Uporaba retrogradnih instrumenata zahtijeva mnogo manje prostora nego kod uporabe konvencionalnih igala ili instrumenata.

 Obavite potpunu retrogradnu pripremu kanala prije pripreme suženja. Umetnite instrument u jedan od dva kanala gdje počinje suženje, zatim lagano pomičite duž suženja kako biste stvorili mali žlijeb.

Retrogradt instrument til isthmus RE2

Titaniumnitrid-belagt instrument til retrograd præparation af isthmus mellem rodkanalerne. Skal anvendes sammen med en filholder.

Anvend en lav til middel effektindstilling.

Anvend en lav til høj skyllehastighed, hvis det er passende.

 Sørg for, at incisionen til rodspidsen og knoglekaviteten er så lille som mulig. Brugen af retrograde instrumenter kræver langt mindre plads end brugen af konventionelle filer eller instrumenter.

 Foretag en fuld retrograd præparation af kanalen før præparationen af isthmus. Før instrumentet ind i en af de to kanaler, hvor isthmus begynder. Før det derefter frem langs isthmus for at danne en lille rille.

Retrograad instrument voor isthmus RE2

Met titaannitride gecoat instrument voor de retrograde preparatie van de isthmus tussen de wortelkanalen. Moet worden gebruikt met een vijlhouder.

Gebruik een laag tot middelhoog vermogen.

Gebruik een lage tot hoge irrigatiestroom indien geschikt.

 Neem zo min mogelijk weefsel van de wortelpunt en botholte weg. Het gebruik van retrograde instrumenten vraagt veel minder ruimte dan gebruik van conventionele vijlen of instrumenten.

 Voer een volledige retrograde kanaalpreparatie uit voorafgaand aan de preparatie van de isthmus. Breng het instrument in een van de twee kanalen in waar de isthmus begint, en beweeg het dan voorzichtig langs de isthmus om een kleine groef te maken.

Retrograd instrument til isthmus RE2

Titannitridbelagt instrument til retrograd præparation af isthmus mellom rotkanalene. Må brukes med filholder.

Bruk lav til middels effekt.

Bruk lav til høy irrigasjonsstrøm (hvis dette er egnet).

 Hold snittet i rotens apex og benkaviteten så lite som mulig. Retrograde instrumenter krever mye mindre plass enn konvensjonelle filer eller instrumenter.

 Utfør en komplett retrograd kanalpreparering før isthmus prepareres. Før instrumentet inn i en av de to kanalene der isthmus starter, og før det forsiktig langs isthmus for å lage en liten fure.





RESTORATIVE

Cavity preparation

 Avoid using the HVE (high volume evacuation) to ensure sufficient cooling of the tooth and the instrument. The instrument heats up quickly if the irrigation flow rate is insufficient.

The cavities must be prepared before using the Piezon instruments. Previous restorations must be completely removed. Use a standard excavator for the excavation of tooth decay cavities or caries.

Instruments SD and SM

Partially diamond-coated instruments for preparing distal and mesial cavities without damaging the adjacent tooth.

Instrument SB

Diamond-coated instrument for opening pits and small caries.

Instruments SBd and SBm

Partially diamond-coated instruments for beveling and finishing mesial and distal cavity margins.

Instrument VE

Diamond-coated instrument for preparing the tooth for placement of veneers.

Instrument PF

Diamond-coated instrument for cleaning and enlarging fissures before sealing.

RESTAURACIJA

Priprema šupljine

 Izbjegavajte korištenje HVE-a (evakuatora velikog kapaciteta) kako biste osigurali dostatno hlađenje zuba i instrumenta. Instrument se brzo zagrijava ako je mlaz ispiranja nedovoljan.

Šupljine treba pripremiti prije uporabe Piezon instrumenata. Prethodne restauracije treba u cijelosti ukloniti. Upotrijebite standardni ekskavator za ekskavaciju truleži zuba ili karijesa.

Instrumenti SD i SM

Djelomično dijamantno presvučeni instrumenti za pripremu distalne i mezijalne šupljine bez oštećenja susjednog zuba.

Instrument SB

Dijamantno presvučeni instrumenti za otvaranje udubina i malih karijesa.

Instrumenti SBd i SBm

Djelomično dijamantno presvučeni instrumenti za zakošavanje i završavanje mezijalnih i distalnih rubova šupljine.

Instrument VE

Dijamantno presvučen instrument za pripremu zuba za postavljanje glazure.

Instrument PF

Dijamantno presvučen instrument za čišćenje i povećavanje fisura prije pečaćenja.

RESTAURATIE

Preparatie caviteit

 Gebruik geen krachtige afzuiging om een afdoende koeling van element en instrument veilig te stellen. Als de irrigatiestroom onvoldoende is, wordt het instrument namelijk snel warm.

De caviteiten moeten worden geprepareerd voordat de Piezon-instrumenten worden gebruikt. Eerdere restauraties moeten volledig worden verwijderd. Gebruik een standaard excavator voor de excavatie van caviteiten door tandbederf of cariës.

Instrument SD en SM

Gedeeltelijk met diamant gecoate instrumenten voor de preparatie van distale en mesiale caviteiten zonder het naastgelegen element te beschadigen.

Instrument SB

Diamantinstrument voor het openen van putten en kleine cariëslaesies.

Instrument SBd en SBm

Gedeeltelijk met diamant gecoate instrumenten voor het maken van een bevel en de afwerking van mesiale en distale caviteitsranden.

Instrument VE

Diamantinstrument voor de preparatie van het gebitselement voor het plaatsen van veneers.

Instrument PF

Diamantinstrument voor reiniging en verbreding van fissuren vóór sealing.



RECONSTRUÇÃO

Preparação de cavidades

 Evite usar a aspiração de volume elevado (HVE) para assegurar um arrefecimento suficiente do dente e do instrumento. O instrumento aquece rapidamente se o caudal de irrigação for insuficiente.

As cavidades têm de ser preparadas antes da utilização dos instrumentos Piezon. As reconstruções anteriores têm de ser totalmente removidas. Use um escavador standard para a escavação das cavidades cariadas ou das cáries.

Instrumentos SD e SM

Instrumentos parcialmente diamantados para a preparação de cavidades distais e mesiais sem danificar o dente adjacente.

Instrumento SB

Instrumento diamantado para abertura de fossas e pequenas cáries.

Instrumentos SBd e SBm

Instrumentos parcialmente diamantados para biselar e finalizar as margens de cavidades mesiais e distais.

Instrumento VE

Instrumento diamantado para a preparação do dente para a colocação de verniz.

Instrumento PF

Instrumento diamantado para a limpeza e alargamento de fissuras antes da selagem.

RESTORATIV BEHANDLING

Præparation af kavitæt

 Undgå at bruge HVE (high volume evacuation) for at sikre tilstrækkelig afkøling af tanden og instrumentet. Instrumentet ophedes hurtigt, hvis skyllegennemstrømningens hastighed ikke er tilstrækkelig stor.

Kaviteterne skal præpareres, før Piezon-instrumenterne anvendes. Tidligere rekonstruktioner skal fjernes helt. Brug en standarddekskavator til at ekskavere hule tandkaviteter eller caries.

Instrumenterne SD og SM

Delvist diamantbelagte instrumenter til at præparere distale og mesiale kaviteter uden at beskadige de tilstødende tænder.

Instrument SB

Diamantbelagt instrument til at åbne huller og mindre caries.

Instrumenterne SBd og SBm

Delvist diamantbelagte instrumenter til at affase og efterbehandle mesiale og distale kavitetskanter.

Instrument VE

Diamantbelagt instrument til at præparere tænderne til placering af veneers.

Instrument PF

Diamantbelagt instrument til at rense og udvide fissurer før lukning.

RESTORATIV BEHANDLING

Præparing av kaviteter

 Unngå å bruke HVE (High Volume Evacuation) for å sikre tilstrekkelig avkjøling av tannen og instrumentet. Instrumentet blir raskt varmt hvis irrigasjonsstrømmen er for lav.

Kaviteterne må prepareres før Piezon-instrumentene brukes. Tidligere rekonstruksjoner må fjernes helt. Bruk en standarddekskavator til ekskavering av kaviteter eller caries.

Instrument SD og SM

Delvis diamantbelagte instrumenter til preparering av distale og mesiale kaviteter uten at den tilstøtende tannen skades.

Instrument SB

Diamantbelagt instrument til åpning av hull og små kariesangrep.

Instrument SBd og SBm

Delvis diamantbelagte instrumenter til avfasing og etterbehandling av mesiale og distale kavitetskanter.

Instrument VE

Diamantbelagt instrument til preparering av tannen for innlegging av fasader.

Instrument PF

Diamantbelagt instrument til rengjøring og utviding av fissurer før forsegling.



Amalgams and cementation

Unlike other Piezon instruments, the SP instrument must be used with no irrigation in "Dry Work" mode. If this mode is not available, select the lowest available irrigation flow rate.



These instruments must be activated intermittently because their tip heats up very rapidly. Thus the activation of the instrument must not exceed 1 minute for a maximum use time of 10 minutes.

Instrument SP

Instrument used for the cementation of ceramic inlays, onlays and veneers with highly thixotropic dual-curing composite cements.

The ultrasound oscillations are transmitted through the inlay or onlay to the composite cement. The thixotropic properties and the ultrasound effect liquefy the cement for a short time to spread it evenly.

Amalgami i cementiranje

Za razliku od drugih Piezon instrumenata, SP instrument se mora koristiti bez ispiranja, u suhom načinu rada. Ako taj način rada nije raspoloživ, odaberite najniže raspoloživi mlaz ispiranja.



Instrumente treba aktivirati s prekidima jer se njihov vrh vrlo brzo zagrijava. Aktivacija instrumenta ne smije biti duža od 1 minute za maksimalno vrijeme korištenja od 10 minuta.

Instrument SP

Instrument se koristi za cementiranje keramičkih inlay i onlay ispuna i glazura s izrazitim tiksotropnim dvostrukovezujućim kompozitnim cementima.

Ultrazvučne oscilacije prenose se kroz inlay ili onlay ispunu na kompozitni cement. Tiksotropna svojstva i ultrazvučni efekt kratkotrajno cement pretvaraju u tekućinu kako bi se mogao ravnomjerno raširiti.

Amalgamen en cementering

Anders dan met andere Piezon-instrumenten moet het SP-instrument zonder irrigatie, dus in een droge modus worden gewerkt. Als deze modus niet beschikbaar is, selecteer dan de laagst beschikbare irrigatiestroom.



Deze instrumenten moeten intermitterend worden geactiveerd omdat de tip zeer snel warm wordt. Daarom mag de activering van het instrument niet langer dan 1 minuut aanhouden, met een maximale werktijd van 10 minuten.

Instrument SP

Instrument gebruikt voor de cementering van keramische inlays, onlays en veneers met sterk thixotropische, dual uithardende composietcementen.

De ultrasone trillingen worden via de inlay of onlay doorgegeven naar het composietcement. De thixotropische eigenschappen en het ultrageluid maken het cement gedurende korte tijd vloeibaar zodat het gelijkmatig wordt verspreid.





Amalgamas e cimentação

Ao contrário de outros instrumentos Piezon, o instrumento SP deve ser usado sem irrigação no modo "Dry Work". Se este modo não estiver disponível, seleccione o caudal de irrigação mais baixo possível.

 Estes instrumentos têm de ser activados intermitentemente porque a respectiva ponta aquece muito rapidamente. Assim, a activação do instrumento não pode exceder 1 minuto durante um período máximo de utilização de 10 minutos.

Instrumento SP

Instrumento usado para a cimentação de inlays, onlays e vernizes cerâmicos com cimentos compósitos de dupla polimerização altamente tixotrópicos.

As oscilações ultrassónicas são transmitidas através do inlay ou onlay para o cimento compósito. As propriedades tixotrópicas e o efeito ultrassónico liquefazem o cimento por um curto período, de modo a que se espalhe de maneira uniforme.

Amalgame og cementering

I modsætning til andre Piezon-instrumenter skal SP-instrumentet SP anvendes uden skylning i tilstanden "Tørarbejde". Hvis denne tilstand ikke er tilgængelig, vælges den skyllegennemstrømning med den laveste hastighed.

 Disse instrumenter skal aktiveres intermitterende, fordi deres spids opvarmes meget hurtigt. Derfor må aktiveringen af instrumentet ikke overskride 1 minut og en maksimal anvendelsestid på 10 minutter.

Instrument SP

Instrument, der anvendes til cementering af keramiske inlays, onlays og veneers med stærkt tixotropiske, dobbelthærdende kompositcementer.

Ultralydssvingninger overføres via inlay eller onlay til kompositcementen. De tixotropiske egenskaber og ultralydsvirkningen gør cementen flydende i et kort stykke tid for at sprede den jævnt.

Amalgam og sementering

I motsetning til andre Piezon-instrumenter må SP-instrumentet brukes uten irrigasjon i modusen "Dry Work". Hvis denne modusen ikke er tilgjengelig, må du velge lavest mulig irrigasjonsstrøm.

 Disse instrumentene må aktiveres på en intermitterende måte fordi spissen varmes opp svært raskt. Instrumentet må ikke aktiveres i mer enn 1 minutt for en maksimal brukstid på 10 minutter.

Instrument SP

Instrument som brukes til sementering av keramiske innlegg, pålegg og fasader med kraftig tixotrop dobbeltherdende komposittsement.

Ultralydsviningene overføres via innlegget eller pålegget til komposittsementen. De tixotrope egenskapene og ultralydeffekten gjør sementen flytende en kort stund, slik at den spres ut jevnt.

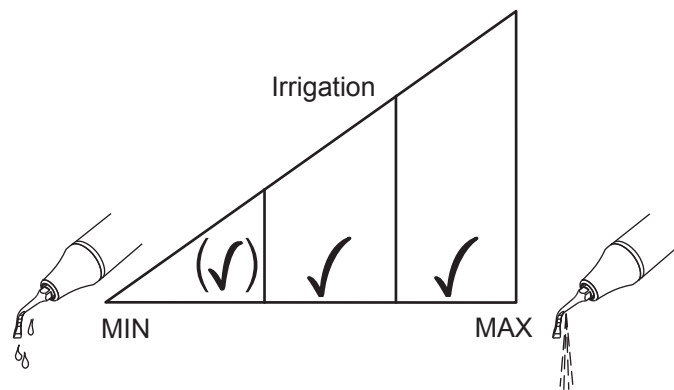
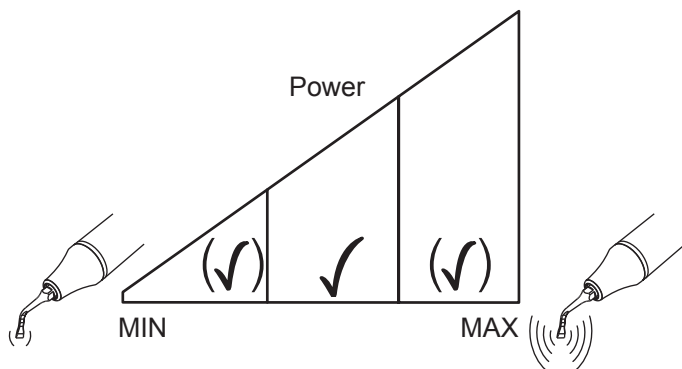
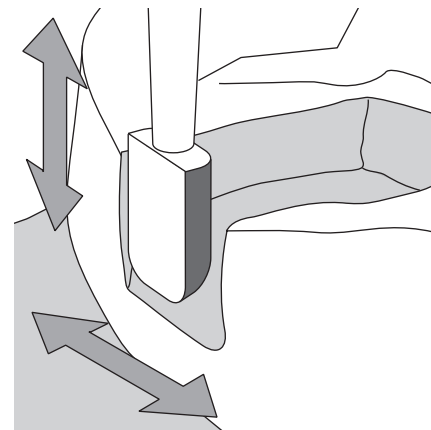
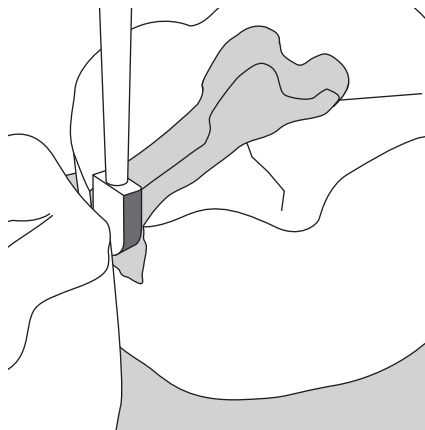
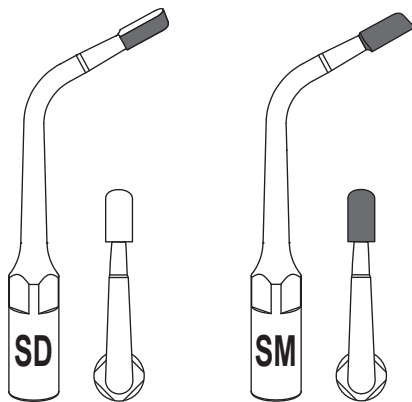



Cavity instruments SD and SM

Partially diamond-coated instruments for preparing distal and mesial cavities without damaging the adjacent tooth.

Use a medium power setting. Use a low or high power setting if suitable.

Use a medium to high irrigation flow rate.

Introduce the instrument from the occlusal side in the cavity and move the instrument up and down slowly to prepare the cavity.

Instrumenti za šupljine SD i SM

Djelomično dijamantno presvučeni instrumenti za pripremu distalne i mezijalne šupljine bez oštećenja susjednog zuba.

Koristite srednje postavke energije. Koristite niske ili visoke postavke energije, ako je prikladno.

Koristite srednju do visoku razinu mlaza za ispiranje.

Uvedite instrument s okluzivne strane u šupljinu i polako ga pomičite gore-dolje kako biste pripremili šupljinu.

Instrumenten SD en SM voor caviteiten

Gedeeltelijk met diamant gecoate instrumenten voor de preparatie van distale en mesiale caviteiten zonder het naastgelegen element te beschadigen.

Gebruik een middelhoog vermogen. Gebruik een lage of hoge irrigatiestroom indien geschikt.

Gebruik een middelhoge tot hoge irrigatiestroom.

Breng het instrument vanaf de occlusale zijde in de caviteit in en beweeg het langzaam op-en-neer om de caviteit te prepareren.

Instrumentos para cavidades SD e SM

Instrumentos parcialmente diamantados para a preparação de cavidades distais e mesiais sem danificar o dente adjacente.

Use um ajuste de potência média. Use um ajuste de potência baixa ou elevada, quando adequado.

Use um caudal de irrigação médio a elevado.

Introduza o instrumento na cavidade pelo lado oclusal e desloque-o lentamente para cima e para baixo, de modo a preparar a cavidade.

Kavitetsinstrumenterne SD og SM

Delvist diamantbelagte instrumenter til at præparere distale og mesiale kaviteter uden at beskadige de tilstødende tænder.

Anvend en middel effektindstilling. Anvend en lav eller en høj effektindstilling, hvis det er passende.

Anvend en middel til høj hastighed for skyllegenemstrømningen.

Indfør instrumentet fra den okklusale side i kaviteten, og bevæg langsomt instrumentet op og ned for at præparere kaviteten.

Kavitetsinstrument SD og SM

Delvis diamantbelagte instrumenter til preparering av distale og mesiale kaviteter uten at den tilstøtende tannen skades.

Bruk middels effekt. Bruk lav eller høy effekt (hvis dette er egnet).

Bruk middels til høy irrigasjonsstrøm.

Før instrumentet inn i kaviteten fra den okklusale siden og preparer kaviteten ved å føre instrumentet langsomt opp og ned.

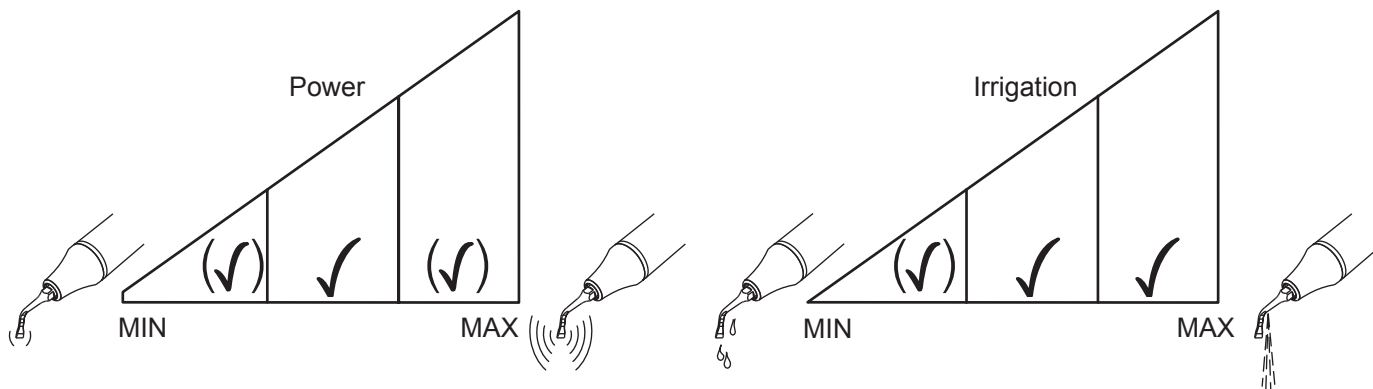
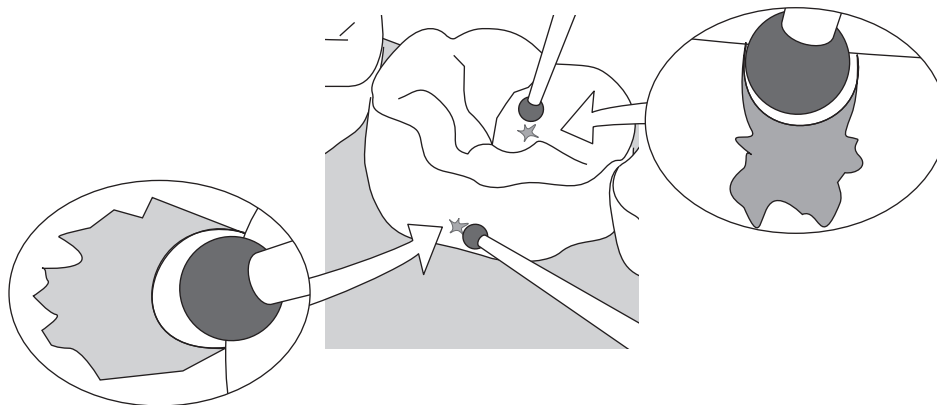
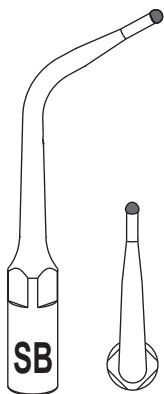



Small ball instrument SB

Diamond-coated instrument for opening pits and small caries.

Use a medium power setting. Use a low or high power setting if suitable.

Use a medium to high irrigation flow rate.

Place the instrument on the pit and move slowly into it with light pressure.

Instrument s malom kuglom SB

Dijamantno presvučeni instrument za otvaranje udubina i malih karijesa.

Koristite srednje postavke energije. Koristite niske ili visoke postavke energije, ako je prikladno.

Koristite srednju do visoku razinu mlaza za ispiranje.

Instrument postavite na udubinu i polako pomičite prema unutra laganim pritiskom.

Klein knopvormig instrument SB

Diamantinstrument voor het openen van putten en kleine cariëslaesies.

Gebruik een middelhoog vermogen. Gebruik een lage of hoge irrigatiestroom indien geschikt.

Gebruik een middelhoge tot hoge irrigatiestroom.

Plaats het instrument op de put en duw langzaam met een lichte druk verder.

Instrumento com pequena ponta esférica SB

Instrumento diamantado para abertura de fossas e pequenas cáries.

Use um ajuste de potência média. Use um ajuste de potência baixa ou elevada, quando adequado.

Use um caudal de irrigação médio a elevado.

Coloque o instrumento na fossa e desloque-o lentamente para o interior da mesma, com uma ligeira pressão.

Lille kugleinstrument SB

Diamantbelagt instrument til at åbne huller og mindre caries.

Anvend en middel effektindstilling. Anvend en lav eller en høj effektindstilling, hvis det er passende.

Anvend en middel til høj hastighed for skyllegenemstrømningen.

Anbring instrumentet på hullet, og flyt langsomt ned i det med et let tryk.

Kuleinstrument SB

Diamantbelagt instrument til åpning av hull og små kariesangrep.

Bruk middels effekt. Bruk lav eller høy effekt (hvis dette er egnet).

Bruk middels til høy irrigasjonsstrøm.

Plasser instrumentet over hullet og før det langsomt ned med et lett trykk.

RESTO

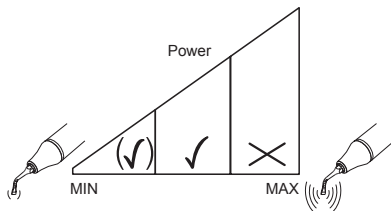
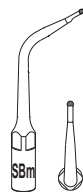
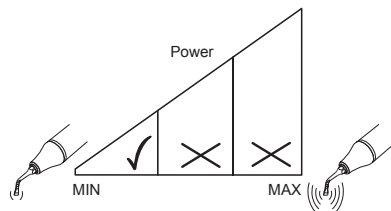
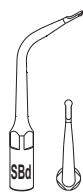
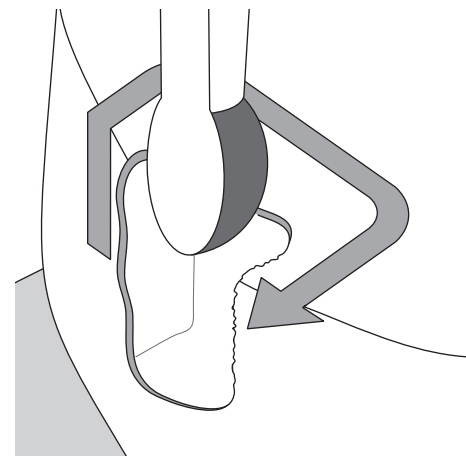
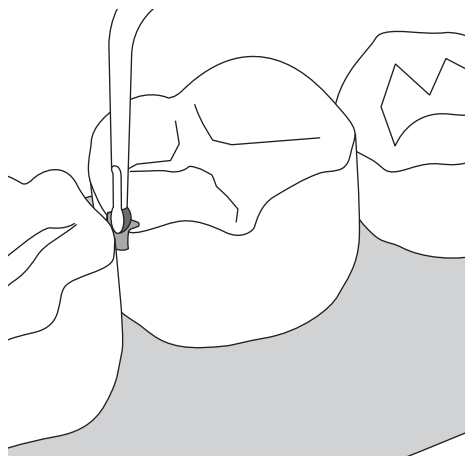
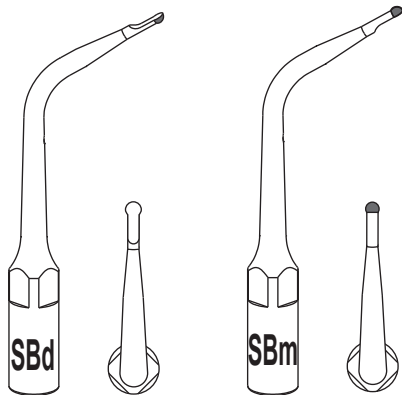



Small ball instruments SBd and SBm

Diamond-coated instruments for beveling and finishing mesial and distal cavity margins.

Use a medium power setting. Use a low or high power setting if suitable.

Use a medium to high irrigation flow rate.

Place the instrument on the margin and move over it slowly with a light pressure.

Instrumenti SBd i SBm s malom kuglom

Dijamantno presvučeni instrumenti za zakošavanje i završavanje mezijalnih i distalnih rubova šupljine.

Koristite srednje postavke energije. Koristite niske ili visoke postavke energije, ako je prikladno.

Koristite srednju do visoku razinu mlaza za ispiranje.

Instrument postavite na rub i polako pomičite preko njega koristeći se laganim pritiskom.

Kleine knopvormige instrumenten SBd en SBm

Diamantinstrumenten voor het maken van een bevel en de afwerking van mesiale en distale caviteitsranden.

Gebruik een middelhoog vermogen. Gebruik een lage of hoge irrigatiestroom indien geschikt.

Gebruik een middelhoge tot hoge irrigatiestroom.

Plaats het instrument op de rand en beweeg er langzaam met een lichte druk overheen.

Instrumentos com pequena ponta esférica SBd e SBm

Instrumentos diamantados para biselar e finalizar as margens de cavidades mesiais e distais.

Use um ajuste de potência média. Use um ajuste de potência baixa ou elevada, quando adequado.

Use um caudal de irrigação médio a elevado.

Coloque o instrumento na margem e desloque-o lentamente ao longo da mesma, com uma ligeira pressão.

De små kugleinstrumenter SBd og SBm

Diamantbelagte instrumenter til at affase og efterbehandle mesiale og distale kavitetskanter.

Anvend en middel effektindstilling. Anvend en lav eller en høj effektindstilling, hvis det er passende.

Anvend en middel til høj hastighed for skyllegenemstrømningen.

Anbring instrumentet på kanten, og flyt langsomt over den med et let tryk.

Kuleinstrument SBd og SBm

Diamantbelagte instrumenter til avfasing og etterbehandling av mesiale og distale kavitetskanter.

Bruk middels effekt. Bruk lav eller høy effekt (hvis dette er egnet).

Bruk middels til høy irrigasjonsstrøm.

Plasser instrumentet på kanten og før det langsomt over den med et lett trykk.

RESTO

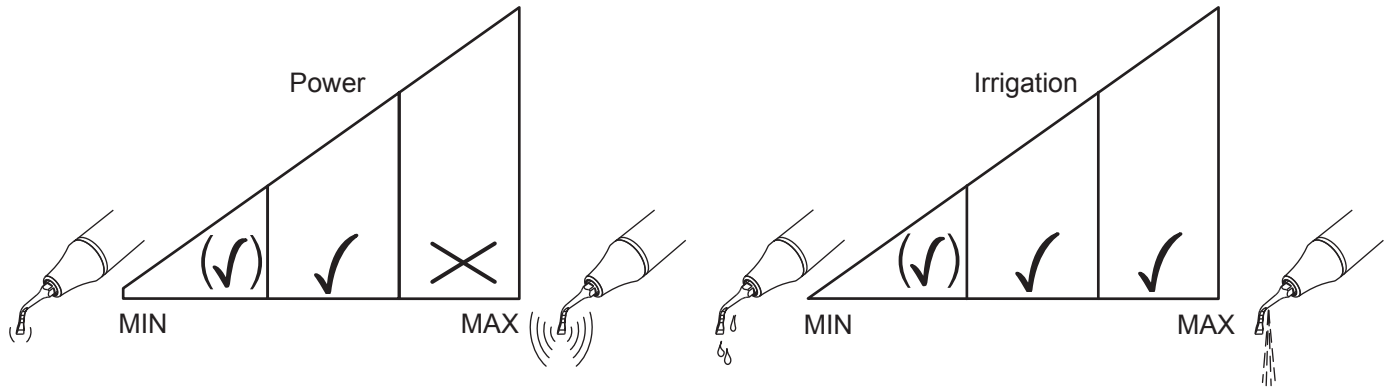
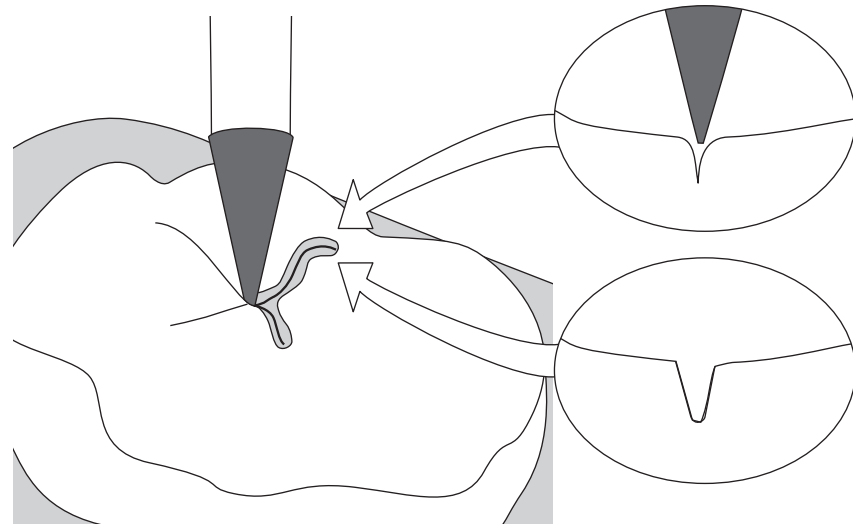
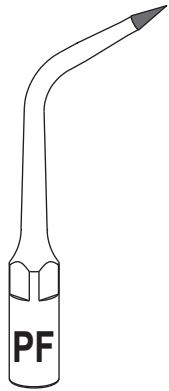



Instrument for pits and fissures PF

Diamond-coated instrument for preparing fissures and pits (fissurotomy).

Use a medium to low power setting.

Use a medium to high irrigation flow rate.

Place the instrument at the fissure and move it along with light pressure.

Instrument za udubine i fisure PF

Dijamantno presvučeni instrument za pripremu fisura i udubina (fisurotomija).

Koristite srednje do niske postavke energije.

Koristite srednju do visoku razinu mlaza za ispiranje.

Postavite instrument na fisuru i pomičite duž nje koristeći se laganim pritiskom.

Instrument voor putten en fissuren PF

Diamantinstrument voor het prepareren van putten en fissuren (fissuurbeslijping).

Gebruik een middelhoog tot laag vermogen.

Gebruik een middelhoge tot hoge irrigatiestroom.

Plaats het instrument in de fissuur en beweeg het er langzaam met een lichte druk langs.

Instrumento para fossas e fissuras PF

Instrumento diamantado para preparação de fissuras e fossas (fissurotomia).

Use um ajuste de potência média a baixa.

Use um caudal de irrigação médio a elevado.

Coloque o instrumento na fissura e desloque-o ao longo da mesma, com uma ligeira pressão.

Instrument til huller og fissurer PF

Diamantbelagt instrument til at præparere fissurer og huller (fissurotomi).

Anvend en middel til lav effektindstilling.

Anvend en middel til høj hastighed for skyllegenemstrømningen.

Anbring instrumentet på fissuren, og flyt det langsomt med et let tryk.

Instrument for hull og fissurer PF

Diamantbelagt instrument til preparering av fissurer og hull (fissurotomi).

Bruk middels til lav effekt.

Bruk middels til høy irrigasjonsstrøm.

Plasser instrumentet på fissuren og før det langs fissuren med et lett trykk.

RESTO



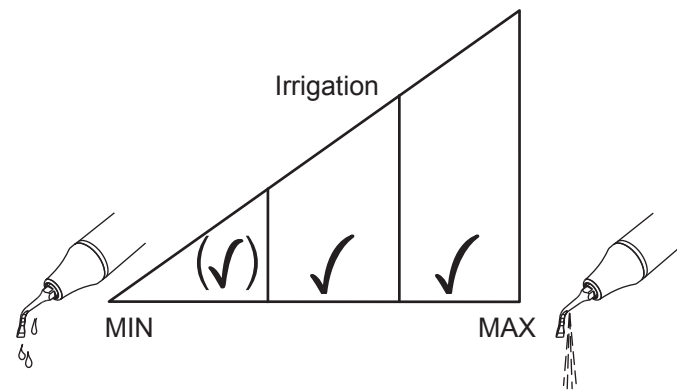
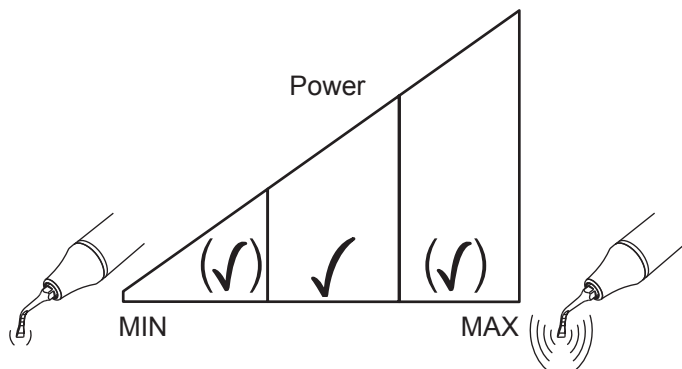
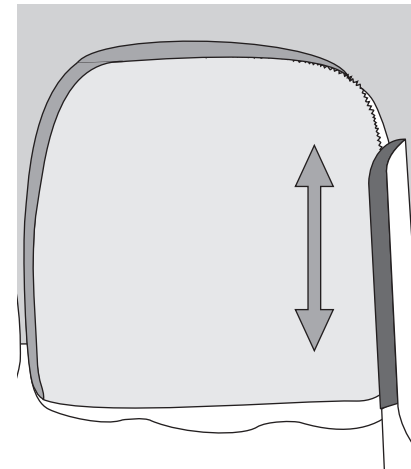
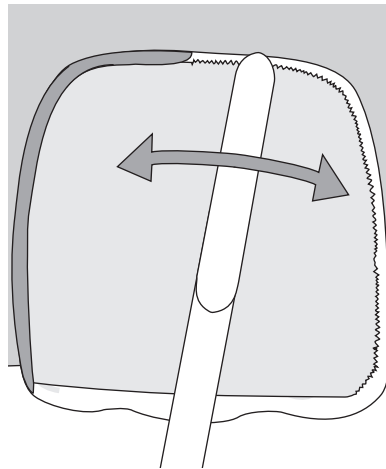
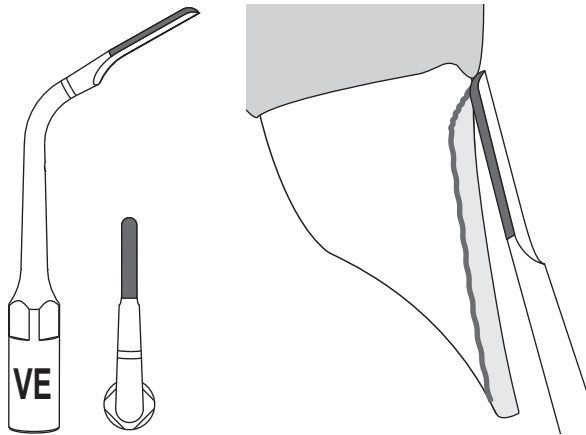



Instrument for veneers VE

Diamond-coated instrument for the finishing of the proximal limits on teeth prepared for placement of veneers.

Use a medium power setting. Use a low or high power setting if suitable.

Use a medium to high irrigation flow rate.

Place the instrument parallel to the surface or on the interproximal limits and move it along the edges while applying a medium pressure.

Instrument za glazure VE

Dijamantno presvučeni instrument za dovršavanje proksimalnih granica na zubima pripremljenim za postavljanje glazura.

Koristite srednje postavke energije. Koristite niske ili visoke postavke energije, ako je prikladno.

Koristite srednju do visoku razinu mlaza za ispiranje.

Postavite instrument paralelno s površinom ili na interproksimalne granice i pomičite uz rub primjenjujući srednji pritisak.

Instrument voor veneers VE

Diamantinstrument voor de afwerking van de proximale grenzen op elementen die zijn geprepareerd voor het plaatsen van veneers.

Gebruik een middelhoog vermogen. Gebruik een lage of hoge irrigatiestroom indien geschikt.

Gebruik een middelhoge tot hoge irrigatiestroom.

Plaats het instrument parallel aan het oppervlak of op de interproximale grenzen en beweeg het langs de randen terwijl u een middelzware druk uitoefent.

Instrumento para vernizes VE

Instrumento diamantado para a finalização dos limites proximais de dentes preparados para a colocação de verniz.

Use um ajuste de potência média. Use um ajuste de potência baixa ou elevada, quando adequado.

Use um caudal de irrigação médio a elevado.

Coloque o instrumento paralelamente à superfície ou nos limites interproximais e desloque-o ao longo das arestas, aplicando uma pressão média.

Instrument til veneers VE

Diamantbelagt instrument til efterbehandling af de proksimale tandgrænser, der er præpareret til placering af veneers.

Anvend en middel effektindstilling. Anvend en lav eller en høj effektindstilling, hvis det er passende.

Anvend en middel til høj hastighed for skyllegenemstrømningen.

Anbring instrumentet parallelt på fladen eller på de interproksimale grænser, og flyt det langs kanterne, mens der påføres et middel tryk.

Instrument for fasader VE

Diamantbelagt instrument til etterbehandling av de proksimale kantene på tenner som er preparert for innlegging av fasader.

Bruk middels effekt. Bruk lav eller høy effekt (hvis dette er egnet).

Bruk middels til høy irrigasjonsstrøm.

Plasser instrumentet parallelt med overflaten av eller på de interproksimale kantene, og før det langs kantene med et middels trykk.

RESTO



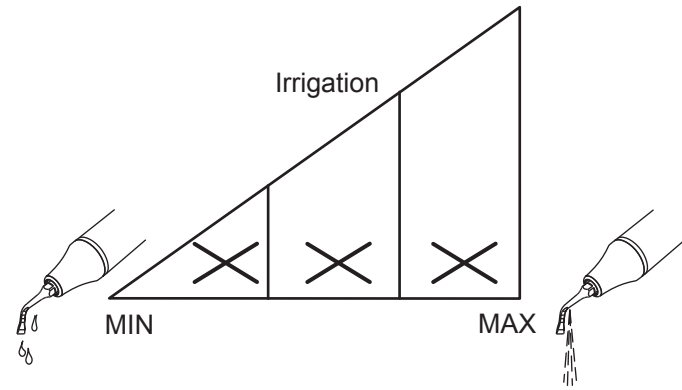
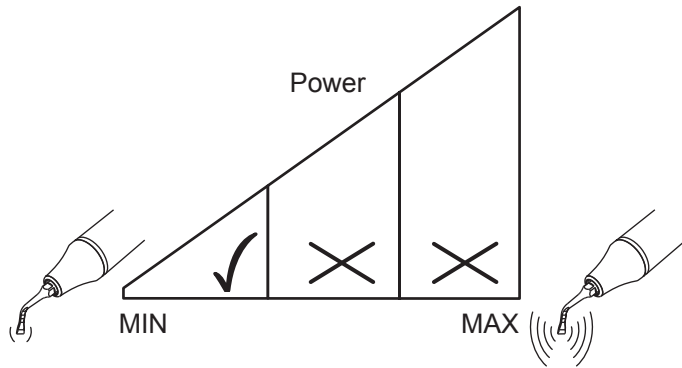
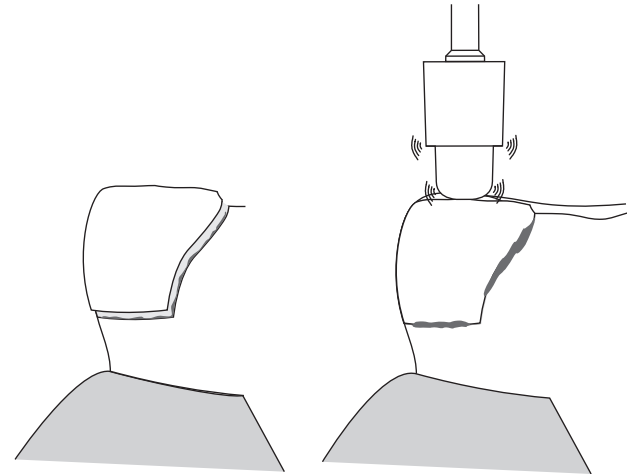
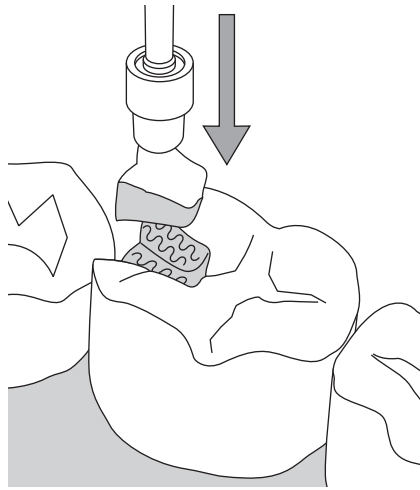
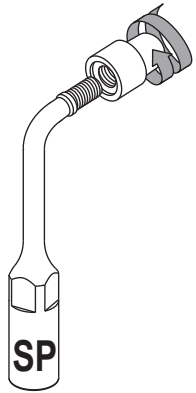



Cementation instrument SP

Instrument for placing and cementing inlays, onlays and veneers with a highly thixotropic dual-curing composite cement.

Use a low power setting and no irrigation.

Screw the cap onto the instrument and tighten it finger tight. Position the inlay or onlay to its final seating position without exerting pressure on the instrument. The composite cement returns to solid state as soon as the ultrasound activation is stopped.

The caps wear during use and must be replaced once the threads are not tight anymore, or when the cap surface shows wear.



We recommend to use a rubber dam to prevent the patient from accidentally swallowing or inhaling parts or debris. When a rubber dam cannot be used, instruct the patient to breathe through the nose.

Instrumento de cimentação SP

Instrumento para a colocação e cimentação de inlays, onlays e vernizes com cimento composto de dupla polimerização altamente tixotrópico.

Use um ajuste de potência baixa, sem irrigação.

Aparafuse a tampa no instrumento e aperte-a à mão. Posicione o inlay ou onlay na posição de assentamento final sem exercer pressão no instrumento. O cimento composto regressa ao estado sólido logo que a activação ultrassónica seja interrompida.

As tampas desgastam-se com a utilização e têm de ser substituídas quando as roscas deixam de manter o aperto ou quando a superfície da tampa mostra sinais de desgaste.



Recomendamos a utilização de um dique de borracha para impedir que o paciente engula ou inspire acidentalmente alguns resíduos ou peças. Quando não for possível utilizar um dique de borracha, instrua o paciente para respirar pelo nariz.

Instrument za cementiranje SP

Instrument se koristi za stavljanje i cementiranje keramičkih inlay i onlay ispuna i glazura s izrazitim tiksotropnim dvostrukovezujućim kompozitnim cementima.

Koristite visoke postavke energije i nemojte koristiti ispiranje.

Zavijte čep na instrument i čvrsto ga stegnite. Postavite inlay ili onlay na konačni položaj bez primjene pritiska na instrument. Kompozitni cement vraća se u čvrsto stanje kad prestane aktivacija ultrazvuka.

Čepovi se troše tijekom uporabe i treba ih zamijeniti kad navoji prestanu biti čvrsti ili kad površina izgleda istrošeno.



Preporučamo korištenje koferdama kako biste spriječili da pacijent slučajno proguta ili udahne sitne čestice. Ako se koferdam ne može upotrijebiti, uputite pacijenta da diše kroz nos.

Cementeringsinstrument SP

Instrument til placering og cementering af inlays, onlays og veneers med en stærkt tiksotropisk dobbelthærdende kompositcement.

Anvend en lav effektindstilling og ingen skylning.

Skrue hættten på instrumentet, og stram den til med fingrene. Anbring inlay eller onlay på den endelige position uden at trykke på instrumentet. Kompositcementen bliver til en fast masse, så snart ultralydsaktiveringen er stoppet.

Hætterne slides under brug og skal udskiftes, når skruengangene ikke er tætte mere, eller når hættestaden udviser slitage.



Vi anbefaler at anvende en koferdam for at forhindre, at patienten kommer til at synke eller indånde dele eller debris. Hvis der ikke kan anvendes en koferdam, skal patienten instrueres i at trække vejret gennem næsen.

Instrument voor cementering SP

Instrument voor het plaatsen en cementeren van inlays, onlays en veneers met een sterk thixotropisch, dual uithardend composietcement.

Gebruik een laag vermogen en geen irrigatie.

Schroef de kap op het instrument en draai deze vingerstrak aan. Plaats de inlay of onlay op de uiteindelijke seatingpositie zonder druk op het instrument uit te oefenen. Het composietcement wordt weer vast zodra de activering van het ultrageluid wordt gestopt.

De kappen slijten tijdens gebruik en moeten worden vervangen zodra ze niet meer goed kunnen worden vastgedraaid of wanneer het oppervlak van de kap slijtage vertoont.



We bevelen aan een rubberdam te gebruiken om te voorkomen dat de patiënt per ongeluk deeltjes doorslikt of inhaleert. Instrueer de patiënt door de neus te ademen wanneer er geen rubberdam kan worden gebruikt.

Sementeringsinstrument SP

Instrument til plassering og sementering av innlegg, pålegg og fasader med kraftig tiksotrop dobbelthærdende komposittsement.

Bruk lav effekt og ingen irrigasjon.

Skrue hetten på instrumentet og stram den med fingrene. Plasser innlegget/pålegget der det skal sitte uten å bruke kraft på instrumentet. Komposittsementen får tilbake sin faste form når ultralyd-aktiveringen stopper.

Hettene blir utsatt for slitasje under bruk og må byttes ut når gjengene ikke lenger er tette, eller når det er tegn til slitasje på overflaten.



Vi anbefaler å bruke en gummiduk for å hindre at pasienten svelger eller inhalerer deler eller løse rester. Hvis dette ikke kan brukes, må pasienten få beskjed om å puste gjennom nesen.



PERIODONTICS

 Avoid using the HVE (high volume evacuation) to ensure sufficient cooling of the tooth and the instrument. The instrument heats up quickly if the irrigation flow rate is insufficient.

Instruments PL1 and PL2

The instruments PL1 (left-curved) and PL2 (right-curved) are used for periodontal debridement with difficult access to the approximal surfaces.

Instrument PL3

Instrument for the irrigation and disinfection of periodontal pockets with an antimicrobial solution.

Instruments PL4 and PL5

The instruments PL4 (left-curved) and PL5 (right-curved) with a ball-shaped tip are used for debridement in root furcations and concavities.

Instrument HPL3 (coarse)

Diamond-coated instrument (70 µm roughness) for in-depth root debridement using direct vision (flap technique), as well as for smoothing restoration overhang and expanding root furcations.

Instrument DPL3 (smooth)

Diamond-coated instrument (15 µm roughness) for polishing surfaces first cleaned and shaped using the instrument HPL3 above.

PARODONTOLOGIJA

 Izbjegavajte korištenje HVE-a (evakuatora velikog kapaciteta) kako biste osigurali dostatno hlađenje zuba i instrumenta. Instrument se brzo zagrijava ako je mlaz ispiranja nedovoljan.

Instrumenti PL1 i PL2

Instrumenti PL1 (savinuti u lijevo) i PL2 (savinuti u desno) koriste se kod parodontološkog debridmana s teškim pristupom aproksimalnim površinama.

Instrument PL3

Instrument za ispiranje i dezinfekciju parodontalnih džepova pomoću antimikrobske otopine.

Instrumenti PL4 i PL5

Instrumenti PL4 (savinuti u lijevo) i PL5 (savinuti u desno) s vrhom u obliku kugle koriste se za debridman u furkacijama i izdubljenjima.

Instrument HPL3 (hrapav)

Dijamantno presvučeni instrument (hrapavost od 70 µ) za dubinski debridman korijena korištenjem izravnog pogleda (flap tehnika) kao i za zagladivanje restauracija koje vise i šire furkacije korijena.

Instrument DPL3 (gladak)

Dijamantno presvučeni instrument (hrapavost od 15 µm) za poliranje površina koje su prethodno očišćene i oblikovane instrumentom HPL3.

PARODONTIE

 Gebruik geen krachtige afzuiging om een afdoende koeling van element en instrument veilig te stellen. Als de irrigatiestroom onvoldoende is, wordt het instrument namelijk snel warm.

Instrument PL1 en PL2

De instrumenten PL1 (kromming naar links) en PL2 (kromming naar rechts) worden gebruikt voor parodontaal debridement met lastige toegang tot de proximale oppervlakken.

Instrument PL3

Instrument voor irrigatie en desinfectie van pockets met een antimicrobiële oplossing.

Instrument PL4 en PL5

De instrumenten PL4 (kromming naar links) en PL5 (kromming naar rechts) met een knopvormige tip worden gebruikt voor debridement in furcaties en concaviteiten.

Instrument HPL3 (grof)

Diamantinstrument (70 µm-ruwheid) voor diep worteldebridement onder direct zicht (flaptechniek), evenals voor gladmaken van overhangende gedeelten van restauraties en verbreden van furcaties.

Instrument DPL3 (glad)

Diamantinstrument (15 µm-ruwheid) voor polijsten van oppervlakken die eerst zijn gereinigd en gevormd met bovengenoemd instrument HPL3.



PERIODONTIA

 Evite usar a aspiração de volume elevado (HVE) para assegurar um arrefecimento suficiente do dente e do instrumento. O instrumento aquece rapidamente se o caudal de irrigação for insuficiente.

Instrumentos PL1 e PL2

Os instrumentos PL1 (curvados à esquerda) e PL2 (curvados à direita) são utilizados para o desbridamento periodôntico de superfícies proximais quando o acesso às mesmas é difícil.

Instrumento PL3

Instrumento para a irrigação e desinfecção de bolsas periodonticas com uma solução antimicrobiana.

Instrumentos PL4 e PL5

Os instrumentos PL4 (curvados à esquerda) e PL5 (curvados à direita) com ponta esférica são utilizados para o desbridamento de canais radiculares e concavidades.

Instrumento HPL3 (abrasivo)

Instrumento diamantado (rugosidade de 70 µm) para o desbridamento de raízes em profundidade, sob observação directa (técnica de retalho), e para alisamento de saliências resultantes de reconstruções e alargamento de canais radiculares.

Instrumento DPL3 (liso)

Instrumento diamantado (rugosidade de 15 µm) para polimento de superfícies anteriormente limpas e formadas com o instrumento HPL3 acima referido.

PARODONTI

 Undgå at bruge HVE (high volume evacuation) for at sikre tilstrækkelig afkøling af tanden og instrumentet. Instrumentet ophedes hurtigt, hvis skyllegennemstrømningens hastighed ikke er tilstrækkelig stor.

Instrumenterne PL1 og PL2

Instrumenterne PL1 (venstre-buede) og PL2 (højre-buede) anvendes til parodontal debridering med vanskelig adgang til de approssimale flader.

Instrument PL3

Instrument til skylning og desinficering af parodontale lommer med en antimikrobiel opløsning.

Instrumenterne PL4 og PL5

Instrumenterne PL4 (venstre-buede) og PL5 (højre-buede) med en kugleformet spids anvendes til debridering i rodfurkationer og konkaviteter.

Instrument HPL3 (groft)

Diamantbelagt instrument (70 µm grovhed) til dybdgående roddebridering under synets vejledning (flapteknik) så vel som til udglatning af rekonstruktionsoverskud og udvidelse af rodfurkationer.

Instrument DPL3 (glat)

Diamantbelagt instrument (15 µm grovhed) til polering af flader, der først er rensset og formet med ovenstående instrument HPL3.

PERIODONTI

 Unngå å bruke HVE (High Volume Evacuation) for å sikre tilstrekkelig avkjøling av tannen og instrumentet. Instrumentet blir raskt varmt hvis irrigasjonsstrømmen er for lav.

Instrument PL1 og PL2

Instrumentene PL1 (venstrebøyd) og PL2 (høyrebøyd) brukes til periodontal debridering på vanskelig tilgjengelige approssimale overflater.

Instrument PL3

Instrument til irrigasjon og desinfisering av periodontale lommer med antimikrobiell løsning.

Instrument PL4 og PL5

Instrumentene PL4 (venstrebøyd) og PL5 (høyrebøyd) med kuleformet spiss brukes til debridering i rotfurkasjoner og konkaviteter.

Instrument HPL3 (grovt)

Diamantbelagt instrument (70 µm grovhet) til dyptgående rotdebridering med direkte innsyn ("flap"-teknikk), samt til utjevning av overheng på rekonstruksjoner og utvidelse av rotfurkasjoner.

Instrument DPL3 (glat)

Diamantbelagt instrument (15 µm grovhet) til polering av overflater som først er blitt rengjort og formet med instrument HPL3 over.

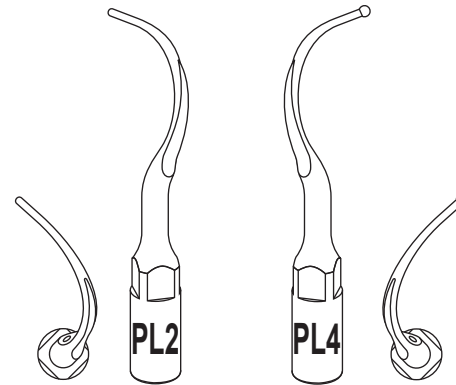
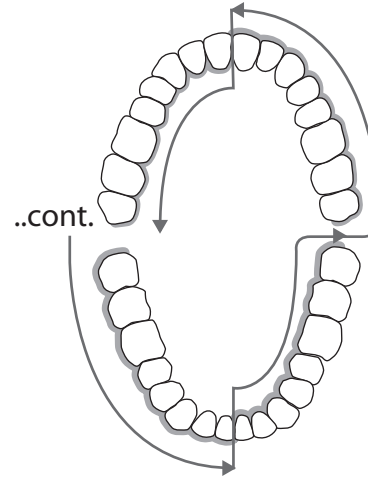
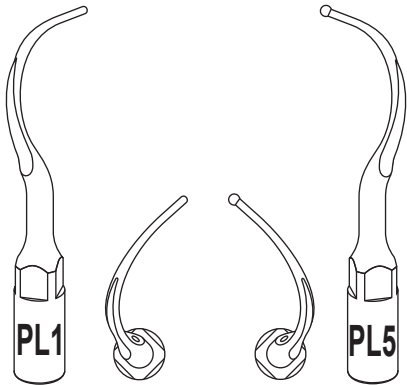
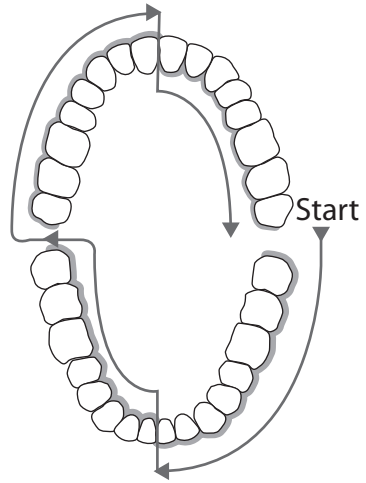



Working with curved instruments

Never direct the tip of the instrument toward the tooth surface.

The graphic shows the example of an efficient process for a full-mouth treatment by taking advantage of the left curved and right curved Piezon instruments. Proceeding in this manner allows for a full-mouth treatment with only one instrument change.

Rad sa zakrivljenim instrumentima

Nemojte usmjeriti vrh instrumenta prema površini zuba

Na ilustraciji je prikazan primjer učinkovitog procesa za tretman cijele usne šupljine iskorištavanjem prednosti Piezon instrumenata koji su savinuti u lijevo i u desno. Postupanje na taj način omogućuje tretman cijele usne šupljine uz samo jednu izmjenu instrumenta.

Werken met gebogen instrumenten

Richt echter nooit de tip van het instrument naar het tandoppervlak.

De illustratie laat het voorbeeld zien van een efficiënt proces voor de behandeling van de gehele mond door gebruik te maken van de naar links en naar rechts gebogen Piezon-instrumenten. Op deze manier kan de gehele mond worden behandeld met slechts één instrumentwisseling.

Trabalhar com instrumentos curvos

Nunca dirija a ponta do instrumento para a superfície do dente.

A ilustração mostra o exemplo de um processo eficiente para um tratamento de toda a boca, tirando partido dos instrumentos Piezon curvados à esquerda e à direita. Este processo permite tratar toda a boca com uma única troca de instrumento.

Sådan arbejdes med buede instrumenter

Aldrig instrumentets spids mod tandens overflade. Illustrationen viser et eksempel på en effektiv proces for behandling af en hel mund ved at drage fordel af de venstre-buede og højre-buede Piezon-instrumenter. Fortsættelse på denne måde muliggør behandling af en hel mund med kun et instrumentskift.

Arbeide med bøyde instrumenter

Spissen på instrumentet må imidlertid aldri rettes mot tannoverflaten.

Illustrasjonen viser et eksempel på en effektiv helmunnsbehandling der man utnytter fordelene ved de venstre- og høyrebøyde Piezon-instrumentene. På denne måten kan hele munnen behandles med kun ett instrumentbytte.

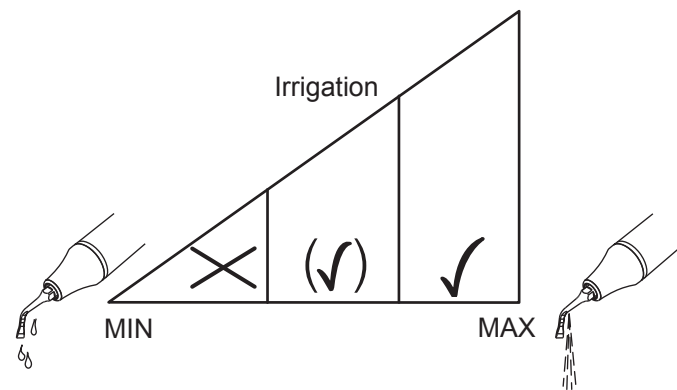
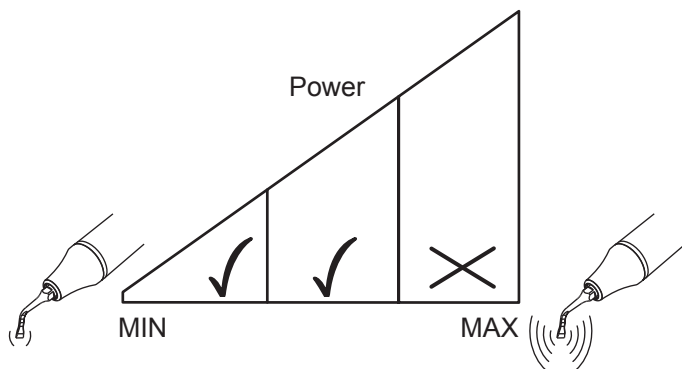
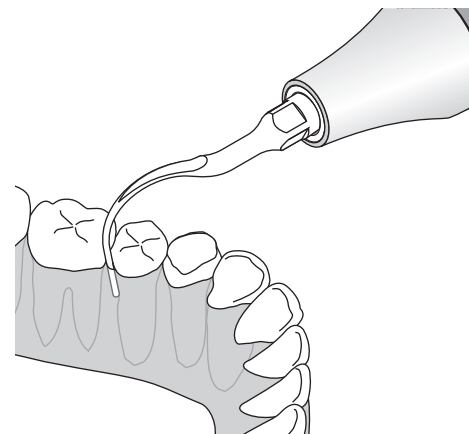
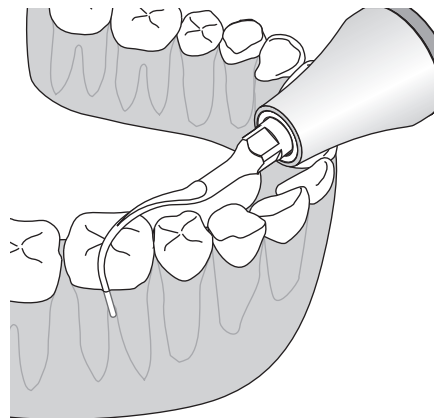
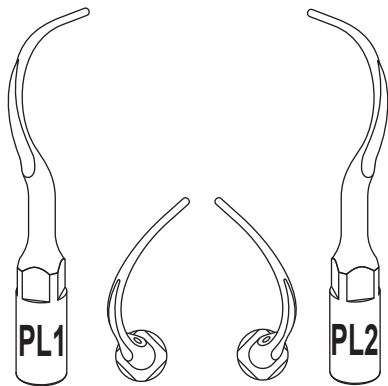



Perio line instruments PL1 and PL2

Curved instruments for periodontal debridement, especially for difficult to reach approximal areas.

Use a low power setting or medium power for hard concretions. Never exceed a medium power setting.

Use a high to medium irrigation flow rate.

For an efficient full-mouth treatment only use the **outside** lateral part of the instrument PL1 and PL2 as shown on page 74.

Apply only a light lateral pressure.

 Do not direct the instrument straight to the enamel surface. Never point the tip of the instrument to the tooth surface.

Instrumentos Perio line PL1 e PL2

Instrumentos curvos para desbridamento periodôntico, especialmente em áreas proximais de difícil acesso.

Use um ajuste de potência baixa ou média para cálculos duros. Nunca ultrapasse um ajuste de potência média.

Use um caudal de irrigação elevado a médio.

Para um tratamento da boca inteira utilizar a parte lateral exterior dos instrumentos PL1 e PL2 como ilustrado na página 78.

 Não direcione o instrumento em posição recta contra a superfície do esmalte. Nunca dirija a ponta do instrumento para a superfície do dente.

Parodontalni linijski Instrumenti PL1 i PL2

Savijeni instrumenti za parodontološki debridman, posebno za aproksimalna područja do kojih je teško doprijeti.

Koristite niske ili srednje postavke energije za tvrde naslage zubnog kamenca. Nikad nemojte prijeći srednje postavke energije.

Koristite visoku do srednju razinu mlaza za ispiranje.

Za učinkovit tretman cijele usne šupljine koristite samo **vanjski** lateralni dio instrumenta PL1 i PL2 kako je prikazano na stranici 74.

Primijenite samo lagani lateralni pritisak.

 Instrument nemojte usmjeriti izravno u površinu cakline. Nikad nemojte usmjeriti vrh instrumenta prema površini zuba.

Paroinstrumenterne PL1 og PL2

Buede instrumenter til parodontal debridering, specielt til vanskeligt tilgængelige approksimale områder.

Anvend en lav eller middel effektindstilling ved hårde tandsten. Anvend aldrig en højere indstilling end middeleffektindstillingen.

Anvend en høj til middel hastighed for skyllegenemstrømningen.

For effektiv behandling af hele munden bruges kun den udvendige, laterale del af instrumentet PL1 og PL2 som vist på side <OV>.

Påfør kun et let lateralt tryk.

 Ret ikke instrumentet lige mod emaljefladen. Ret aldrig instrumentspidsen mod tandfladen.

Perio-lijn instrumenten PL1 en PL2

Gebogen instrumenten voor parodontaal debridement, met name voor lastig te bereiken proximale gebieden.

Gebruik een laag of middelhoog vermogen voor hard tandsteen. Gebruik maximaal een middelhoog vermogen.

Gebruik een hoge tot middelhoge irrigatiestroom.

Gebruik voor een efficiënte behandeling van de gehele mond alleen het buitenste laterale deel van instrument PL1 en PL2 als afgebeeld op pagina <OV>.

Oefen slechts een lichte laterale druk uit.

 Richt het instrument nooit recht op het glazuuroppervlak. Richt de tip van het instrument nooit op het tandoppervlak.

Perio-instrument PL1 og PL2

Bøyd instrumenter til parodontal debridering, specielt til vanskeligt tilgængelige approksimale områder.

Bruk lav effekt eller middels effekt ved hard tannstein. Høyere enn middels effekt må aldri brukes.

Bruk høy til middels irrigasjonsstrøm.

For en effektiv helmunnsbehandling brukes bare den ytre laterale delen av instrumentene PL1 og PL2, som vist på side <OV>.

Bruk kun et lett lateralt trykk.

 Ikke rett instrumentet rett mot emaljeoverflaten. Spissen av instrumentet må aldri peke mot tannoverflaten.

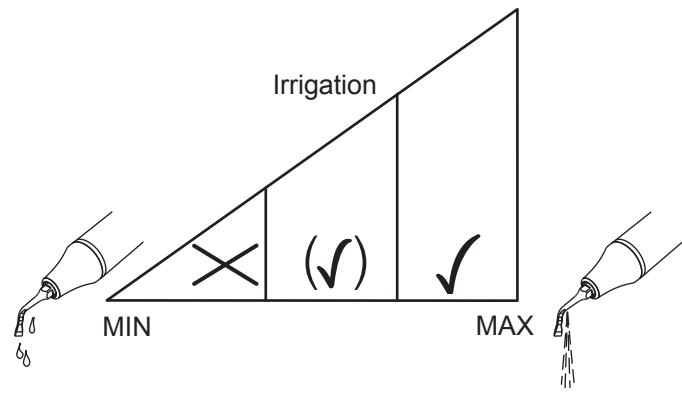
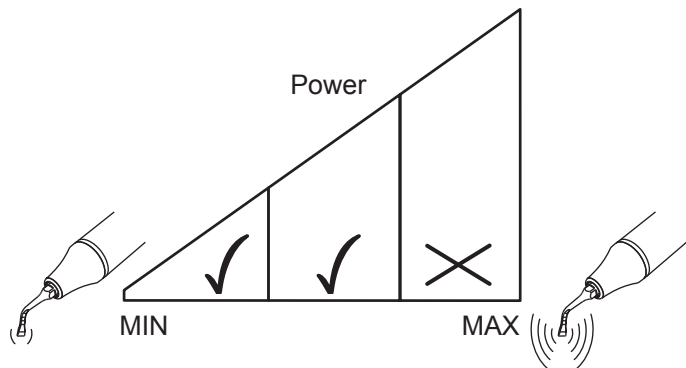
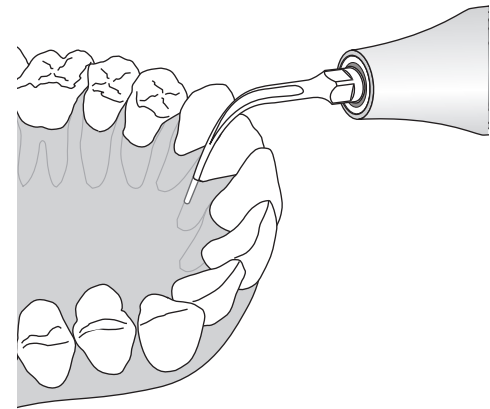
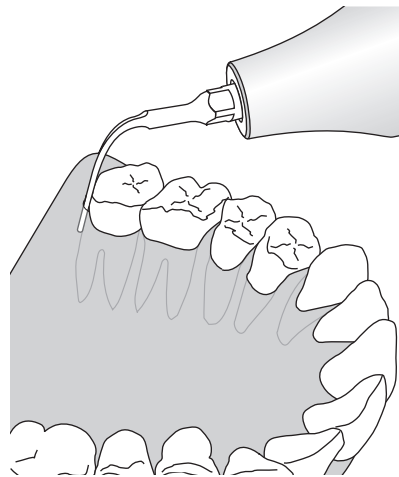
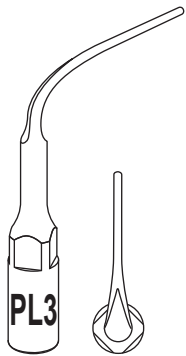



Perio line instrument PL3

Instruments for cleaning and disinfection of periodontal pockets.

Use a low power setting or a medium power setting for hard concretions. Never exceed a medium power setting.

Use a high to medium irrigation flow rate.

Parodontalni linijski instrumenti PL3

Instrumenti za čišćenje i dezinfekciju parodontalnih džepova.

Koristite niske ili srednje postavke energije za tvrde naslage zubnog kamenca. Nikad nemojte prijeći srednje postavke energije.

Koristite visoku do srednju razinu mlaza za ispiranje.

Perio-lijn instrument PL3

Instrumenten voor reiniging en desinfectie van pockets.

Gebruik een laag of middelhoog vermogen voor hard tandsteen. Gebruik maximaal een middelhoog vermogen.

Gebruik een hoge tot middelhoge irrigatiestroom.

Instrumento Perio line PL3

Instrumentos para limpeza e desinfecção de bolsas periodonticas.

Use um ajuste de potência baixa ou média para cálculos duros. Nunca ultrapasse um ajuste de potência média.

Use um caudal de irrigação elevado a médio.

Paroinstrument PL3

Instrumenter til rensning og desinficering af parodontale lommer.

Anvend en lav eller en middel effektindstilling ved hårde tandsten. Anvend aldrig en højere indstilling end middeleffektindstillingen.

Anvend en høj til middel hastighed for skyllegenemstrømningen.

Perio-instrument PL3

Instrumenter til rengjøring og desinfisering av periodontale lommer.

Bruk lav effekt eller middels effekt ved hard tannstein. Høyere enn middels effekt må aldri brukes.

Bruk høy til middels irrigasjonsstrøm.

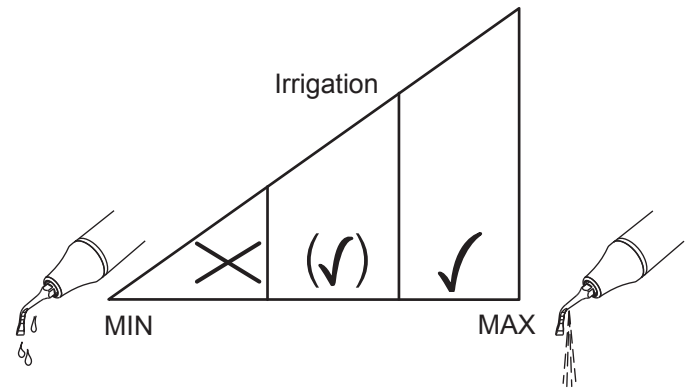
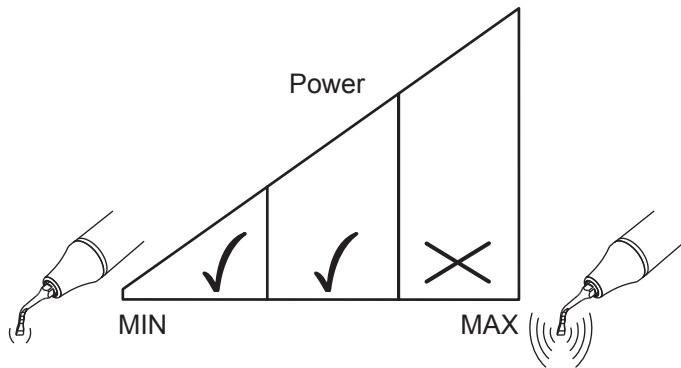
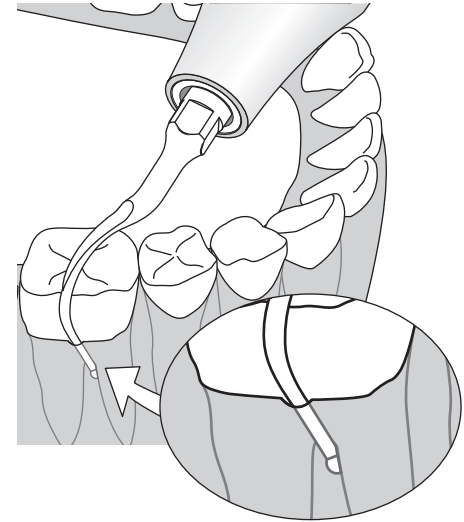
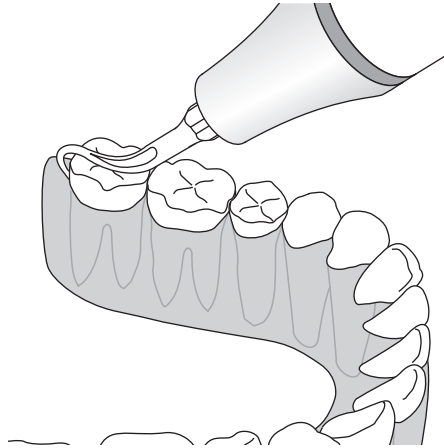
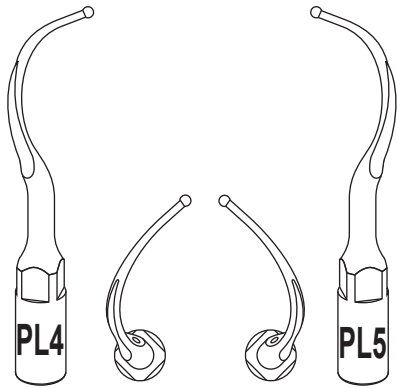



Perio line instruments PL4 and PL5

Curved instruments with a 0.8 mm ball-shaped tip for periodontal debridement of furcations and cavities.

Use a low power setting or a medium power setting for hard concretions. Never exceed a medium power setting.

Use a high to medium irrigation flow rate.

All lateral surfaces of the instrument may be used. Apply only a light lateral pressure.

 Do not direct the instrument straight to the enamel surface. Never point the tip of the instrument to the tooth surface.

Parodontalni linijski instrumenti PL4 i PL5

Savijeni instrumenti s 0,8 mm vrhom u obliku kuglice za parodontalni debridman furkacija i šupljina.

Koristite niske ili srednje postavke energije za tvrde naslage zubnog kamenca. Nikad nemojte prijeći srednje postavke energije.

Koristite visoku do srednju razinu mlaza za ispiranje.

Mogu se koristiti sve lateralne površine instrumenta. Primijenite samo lagani lateralni pritisak.

 Instrument nemojte usmjeriti izravno u površinu cakline. Nikad nemojte usmjeriti vrh instrumenta prema površini zuba.

Perio-lijn instrument PL4 en PL5

Gebogen instrumenten met een knopvormige tip van 0,8 mm voor parodontaal debridement van furcaties en caviteiten.

Gebruik een laag of middelhoog vermogen voor hard tandsteen. Gebruik maximaal een middelhoog vermogen.

Gebruik een hoge tot middelhoge irrigatiestroom.

Alle laterale oppervlakken van het instrument kunnen worden gebruikt. Oefen slechts een lichte laterale druk uit.

 Richt het instrument nooit recht op het glazuerooppervlak. Richt de tip van het instrument nooit op het tandoppervlak.

Instrumentos Perio line PL4 e PL5

Instrumentos curvos com ponta esférica de 0,8 mm para desbridamento periodôntico de canais e cavidades.

Use um ajuste de potência baixa ou média para cálculos duros. Nunca ultrapasse um ajuste de potência média.

Use um caudal de irrigação elevado a médio.

Podem ser usadas todas as superfícies laterais do instrumento. Aplique apenas uma pressão lateral ligeira.

 Não direcione o instrumento em posição recta contra a superfície do esmalte. Nunca dirija a ponta do instrumento para a superfície do dente.

Paroinstrumenterne PL4 og PL5

Buede instrumenter med en 0,8 mm kugleformet spids til parodontal debridering af furkationer og kaviteter.

Anvend en lav eller en middel effektindstilling ved hårde tandsten. Anvend aldrig en højere indstilling end middeleffektindstillingen.

Anvend en høj til middel hastighed for skyllegenemstrømningen.

Alle laterale flader på instrumentet kan anvendes. Påfør kun et let lateralt tryk.

 Ret ikke instrumentet lige mod emaljefladen. Ret aldrig instrumentspidsen mod tandfladen.

Perio-instrument PL4 og PL5

Bøyd instrumenter med en 0,8 mm kuleformet spiss til periodontal debridering av furkasjoner og kaviteter.

Bruk lav effekt eller middels effekt ved hard tannstein. Høyere enn middels effekt må aldri brukes.

Bruk høy til middels irrigasjonsstrøm.

Alle laterale overflater på instrumentet kan brukes. Bruk kun et lett lateralt trykk.

 Ikke rett instrumentet rett mot emaljeoverflaten. Spissen av instrumentet må aldri peke mot tannoverflaten.

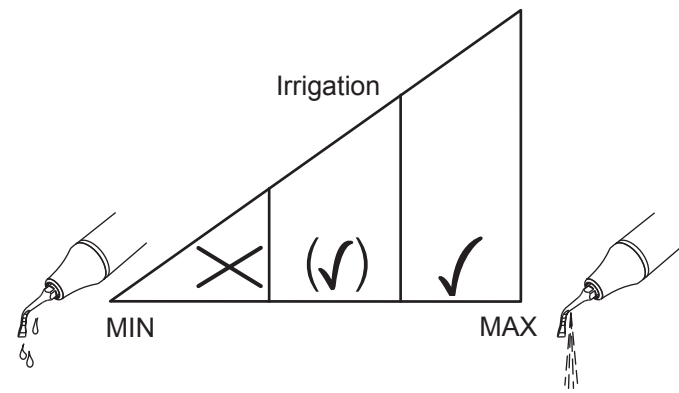
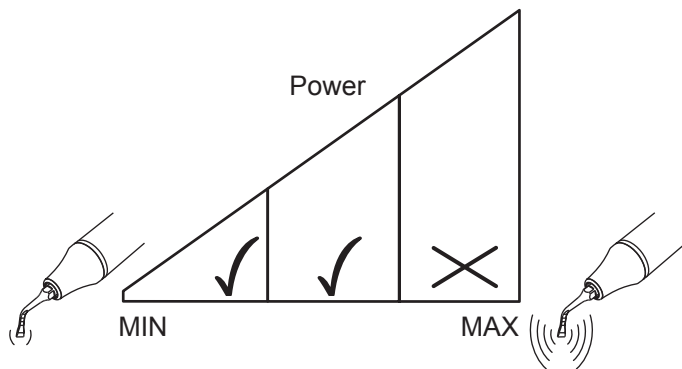
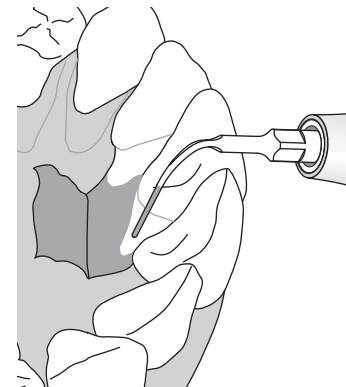
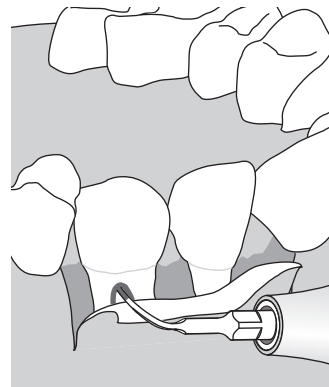
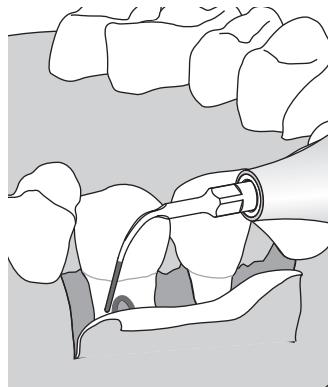
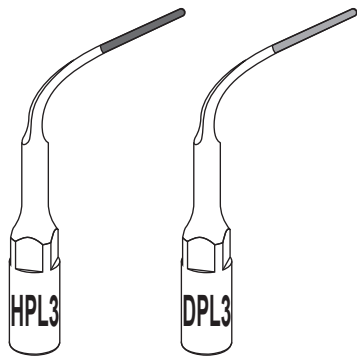



Instruments perio HPL3 and DPL3

HPL3: 70 µm roughness

Diamond-coated instrument for in-depth root debridement under direct vision using a flap technique. Also suitable for smoothing restoration margins and for expanding root furcations.

Use a low to medium power setting.

Use a high to medium irrigation flow rate.

DPL3: 15 µm roughness

Diamond-coated instrument for polishing surfaces previously cleaned and shaped using the instrument HPL3 above.

Use a low to medium power setting and a high irrigation flow rate.

Instrumentos Perio HPL3 e DPL3

HPL3: rugosidade de 70 µm

Instrumento diamantado para desbridamento de raízes em profundidade sob observação directa através da técnica de retalho. Igualmente indicado para alisamento das margens de reconstruções e alargamento de canais radiculares.

Use um ajuste de potência baixa a média.

Use um caudal de irrigação elevado a médio.

DPL3: rugosidade de 15 µm

Instrumento diamantado para polimento de superfícies anteriormente limpas e modeladas com o instrumento HPL3 acima referido.

Use um ajuste de potência baixa a média e um caudal de irrigação elevado.

Parodontalni instrumenti HPL3 i DPL3

HPL3: hrpavost od 70 µm

Dijamantno presvučeni instrument za dubinski debridman korijena s izravnim vizualnim kontaktom korištenjem flap tehnike. Prikladno i za zaglađivanje rubova restauracije i za širenje korijenskih furkacija.

Koristite niske do srednje postavke energije.

Koristite visoku do srednju razinu mlaza za ispiranje.

DPL3: hrpavost od 15 µm

Dijamantno presvučeni instrument za poliranje površina koje su prethodno očišćene i oblikovane instrumentom HPL3.

Koristite niske do srednje postavke energije i koristite visoki mlaz ispiranja.

Paroinstrumenterne HPL3 og DPL3

HPL3: 70 µm grovhet

Diamantbelagt instrument til dybdegående roddebridering under synets vejledning ved hjælp af en flapteknik. Også velegnet til udglatning af rekonstruktionskanter og til at udvide rodfurkationer.

Anvend en lav til middel effektindstilling.

Anvend en høj til middel hastighed for skyllegennemstrømningen.

DPL3: 15 µm grovhet

Diamantbelagt instrument til polering af flader, der tidligere er renset og formet med ovenstående instrument HPL3.

Anvend en lav til middel effektindstilling og en høj hastighed for skyllegennemstrømning.

Instrumenten perio HPL3 en DPL3

HPL3: 70 µm-ruwheid

Diamantinstrument voor diep worteldebridement onder direct zicht met toepassing van een flaptechniek. Ook geschikt voor gladmaken van restauratieranden en breder maken van furcaties.

Gebruik een laag tot middelhoog vermogen.

Gebruik een hoge tot middelhoge irrigatiestroom.

DPL3: 15 µm-ruwheid

Diamantinstrument voor polijsten van oppervlakken die eerder zijn gereinigd en gevormd met bovengenoemd instrument HPL3.

Gebruik een laag tot middelhoog vermogen en een hoge irrigatiestroom.

Perio-instrument HPL3 og DPL3

HPL3: 70 µm grovhet

Diamantbelagt instrument til dyptgående rotdebridering med direkte innsyn ved hjelp av "flap"-teknikk. Også egnet til utjevning av overheng på rekonstruksjoner og utvidelse av rotfurkasjoner.

Bruk lav til middels effekt.

Bruk høy til middels irrigasjonsstrøm.

DPL3: 15 µm grovhet

Diamantbelagt instrument til polering av overflater som tidligere er blitt rengjort og formet med instrument HPL3 over.

Bruk lav til middels effekt og høy irrigasjonsstrøm.





CLEANING, DISINFECTING AND STERILIZING

ČIŠĆENJE, DEZINFEKCIJA I STERILIZACIJA

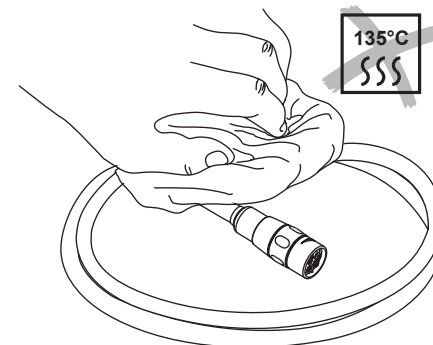
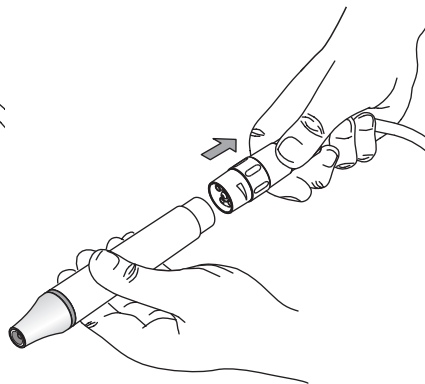
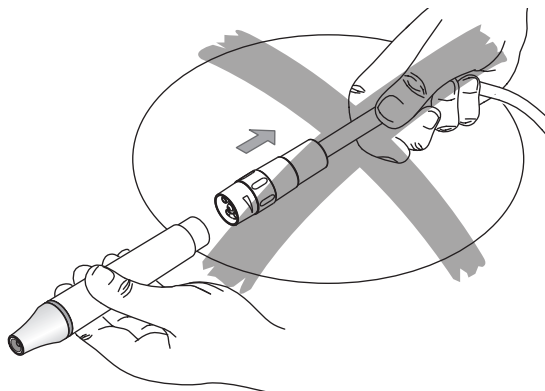
REINIGEN, DESINFECTEREN EN STERILISEREN





 Follow present-day regulations enforced in the country about reprocessing.

 Do not immerse the handpiece or the cords in a disinfectant solution as this may damage them.

 Use only an alcohol-based, commercially available (ethanol, isopropanol), colorless disinfectant. The use of scouring powder or abrasive sponge will damage the surfaces.

Place the cleaned and disinfected components in sterilization bags or in the EMS SystemBox (stains may appear on the SystemBox surface after sterilizing).

 Slijedite trenutno važeće propise o reprocesiranju koji se primjenjuju u vašoj zemlji.

 Nasadnik ili kablove nemojte uranjati u sredstvo za dezinficiranje jer ih na taj način možete oštetiti.

 Jedinicu čistite samo komercijalnim sredstvom za dezinfekciju na bazi alkohola (etanolum, izopropanolom) bez boje. Upotreba prejakih prašaka ili abrazivnih spužvi može oštetiti površine.

Očišćene i dezinficirane dijelove stavite u vrećice za sterilizaciju ili u EMS SystemBox (na površini SystemBoxa mogu se pojaviti mrlje nakon sterilizacije).

 Volg de geldende landelijke voorschriften voor verwerking.

 Dompel het handstuk of de snoeren niet in een ontsmettingsoplossing omdat ze hierdoor beschadigd kunnen raken.

 Gebruik uitsluitend een commercieel verkrijgbaar kleurloos ontsmettingsmiddel op alcoholbasis (ethanol, isopropanol). Het gebruik van een schuurpoeder of -spons zal de oppervlakken beschadigen.

Plaats de gereinigde en gedesinfecteerde onderdelen in sterilisatiezakken of in de EMS SystemBox (na sterilisatie kunnen er vlekken op het oppervlak van de box verschijnen).



LIMPEZA, DESINFECÇÃO E ESTERILIZAÇÃO

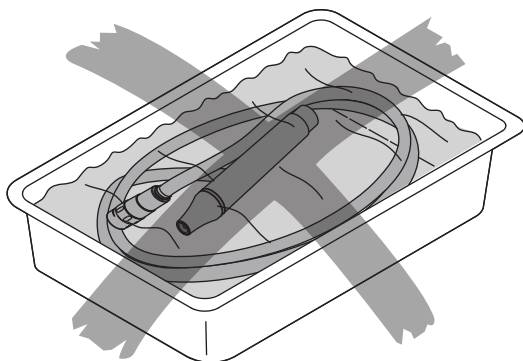

RENGØRING, DESINFICERING OG STERILISERING

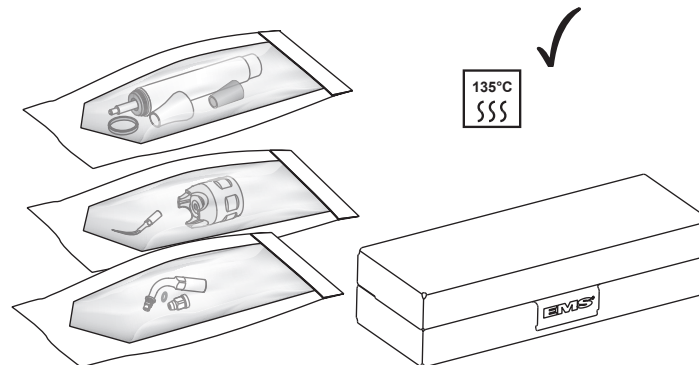

RENGJØRING, DESINFISERING OG STERILISERING

! Siga a regulamentação relativa ao reprocessamento em vigor no seu país.

! Não mergulhe a peça de mão nem as mangueiras em solução desinfetante para não danificar.

! Use apenas um desinfetante incolor à base de álcool disponível no mercado (etanol, isopropanol). A utilização de pós de limpeza ou de esponjas abrasivas danificará as superfícies.

Coloque os componentes limpos e desinfetados em sacos de esterilização ou na EMS SystemBox (podem aparecer manchas na superfície da SystemBox após a esterilização).

! Følg de bestemmelser om genbehandling, der gælder i landet i dag.

! Læg ikke håndstykket eller ledningerne i en desinficerende opløsning, da dette kan beskadige dem.

! Brug kun et spritbaseret (ethanol, isopropanol), farveløst desinficeringsmiddel, der fås i handlen. Anvendelsen af skurepulver eller slibende svampe vil beskadige fladerne.

Anbring de rengjorte og desinficerede komponenter i steriliseringsposer eller i EMS SystemBox'en (der kan forekomme pletter på SystemBox'ens overflade efter sterilisering).

! Følg gjeldende bestemmelser om behandling av produkter etter bruk i ditt land.

! Håndstykket eller ledningene må ikke legges i desinfiseringsløsning, det kan skade utstyret.

! Bruk kun et alkoholbasert og kommersielt tilgjengelig (etanol, isopropanol) fargeløst desinfiseringsmiddel. Bruk av skurepulver eller skuresvamper vil skade overflatene.

Plasser de rengjorte og desinfiserte delene i steriliseringsposer eller i EMS SystemBox (det kan være synlige flekker på overflaten av SystemBox etter sterilisering).



Instrument disassembly and cleaning

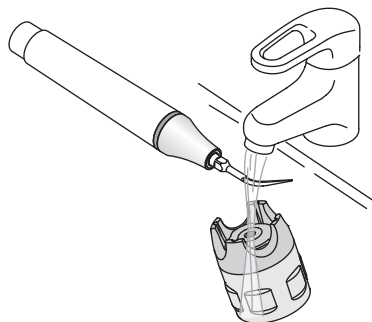

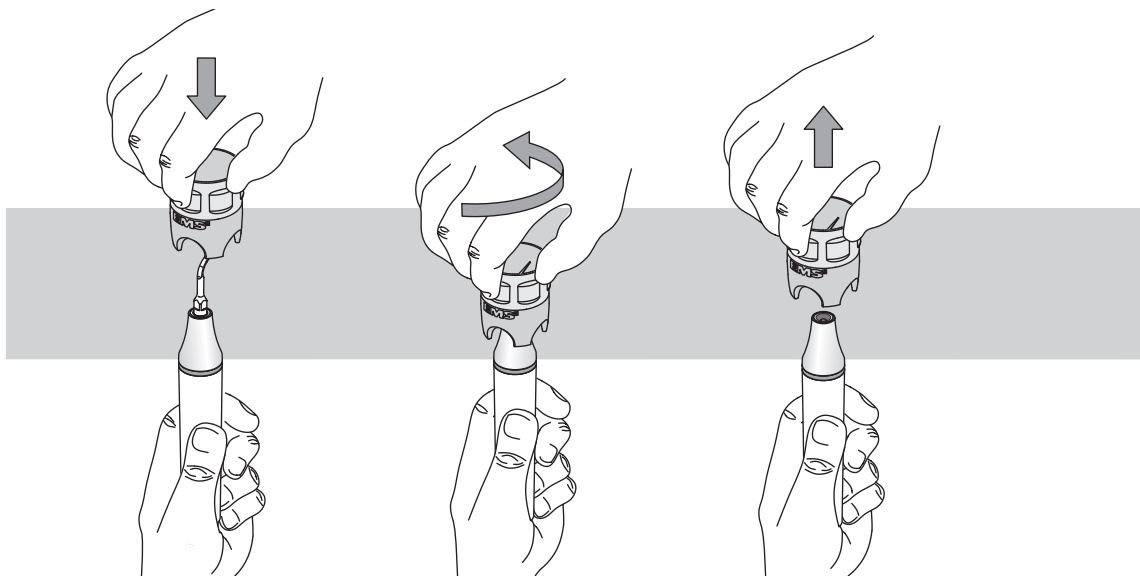

Rastavljanje i čišćenje instrumenta





Demontage en reiniging instrument

 Clean the instruments with running water before disinfection.

 Please follow the recommendations of the Reprocessing Instructions manual delivered with your product regarding the procedures for cleaning, disinfecting, sterilizing and packing of the components.

 Očistite instrument i kombinirani ključ pod mlazom vode prije dezinficiranja.

 Molimo pridržavajte se uputa u svezi s čišćenjem, dezinfekcijom, sterilizacijom i pakiranjem komponenta u priručniku "Upute za reprocesiranje" koji je isporučen s vašim proizvodom.

 Reinig de instrumenten vóór desinfectie onder stromend water.

 Houd u aan de aanbevelingen van de handleiding 'Instructies voor verwerking' die met uw product is meegeleverd, voor de procedures voor reiniging, desinfectie, sterilisatie en verpakking van de onderdelen.







Desmontagem e limpeza dos instrumentos

Demontering og rengøring af instrumenter

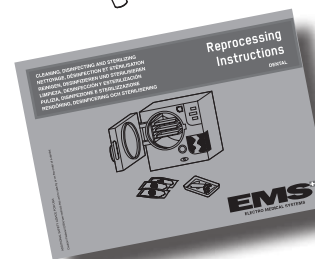
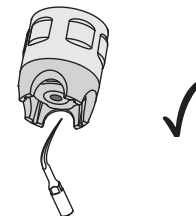
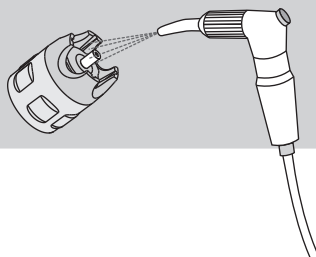
Demontering og rengjøring av instrumenter



 Limpe os instrumentos com água corrente antes de os desinfetar.

 Relativamente à limpeza, desinfecção, esterilização e embalagem dos componentes, deve respeitar todas as recomendações do manual de instruções de reprocessamento que acompanha o produto.

 Rengør instrumenterne med rindende vand før desinficering.

 Følg anbefalingerne i vejledningen "Instruktioner i genbehandling", der blev leveret sammen med dit produkt, vedrørende procedurerne for rengøring, desinficering og sterilisering af komponenterne

 Rengjør instrumentene med rennende vann før desinfisering.

 Følg anbefalingene om rengjøring, desinfisering, sterilisering og emballering av delene i håndboken "Instruksjoner for behandling etter bruk" som følger med produktet.





Handpiece disassembly and cleaning



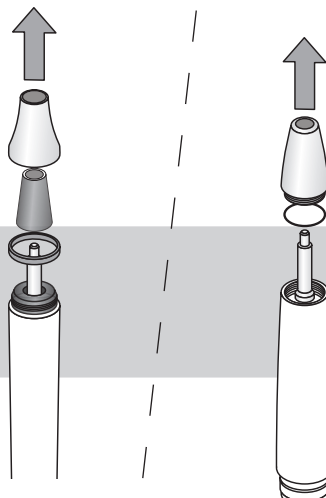

Rastavljanje i čišćenje nasadnika





Demontage en reiniging handstuk





 Unscrew the cap and the light guide (when equipped) to clean each component under running water before disinfection.

 Please follow the recommendations of the Reprocessing Instructions manual delivered with your product regarding the procedures for cleaning, disinfecting, sterilizing and packing of the components.

 Regularly check that the handpiece O-rings are not damaged.

 Odvrnite čep i svjetlosni vodič (ako postoji) kako biste svaki dio očistili pod mlazom vode prije dezinfekcije

 Molimo pridržavajte se uputa u svezi s čišćenjem, dezinfekcijom, sterilizacijom i pakiranjem komponenata u priručniku "Upute za reprocessiranje" koji je isporučen s vašim proizvodom.

 Redovito provjeravajte jesu li o-prstenovi nasadnika oštećeni.

 Schroef de cap en de lichtgeleider (indien van toepassing) los om elk onderdeel vóór desinfectie onder stromend water te reinigen.

 Houd u aan de aanbevelingen van de handleiding 'Instructies voor verwerking' die met uw product is meegeleverd, voor de procedures voor reiniging, desinfectie, sterilisatie en verpakking van de onderdelen.

 Controleer regelmatig of de O-ringen van het handstuk niet beschadigd zijn.





Desmontagem e limpeza da peça de mão

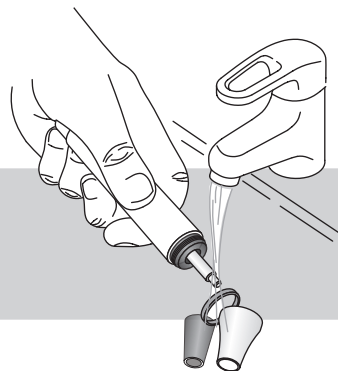

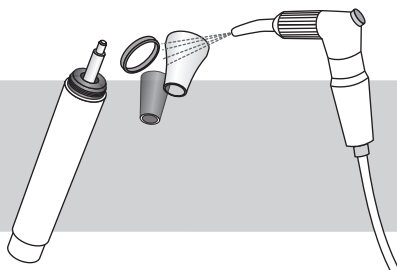

Demontering og rengøring af håndstykket

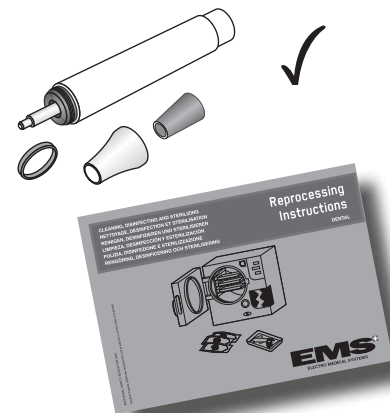

Demontering og rengjøring av håndstykker





 Antes de proceder à desinfecção, desapele a tampa e a guia de luz (quando existir) para limpar cada componente em água corrente.

 Relativamente à limpeza, desinfecção, esterilização e embalagem dos componentes, deve respeitar todas as recomendações do manual de instruções de reprocessamento que acompanha o produto.

 Verifique regularmente se os O-rings da peça de mão não apresentam danos.

 Skru hættten og lyslederen af (når den forefindes) for at rengøre hver komponent under rindende vand før desinficering.

 Følg anbefalingerne i vejledningen Instruktions i genbehandling, der blev leveret sammen med dit produkt, vedrørende procedurerne for rengøring, desinficering, sterilisering og pakning af komponenterne.

 Kontroller regelmæssigt, at håndstykkets O-ringe ikke er beskadigede.

 Skru løs hetten og lyslederen (hvis dette finnes) og rengjør hver del under rennende vann før desinfisering.

 Følg anbefalingene om rengjøring, desinfisering, sterilisering og emballering av delene i håndboken "Instruksjoner for behandling etter bruk" som følger med produktet.

 Kontroller jevnlig at O-ringene på håndstykket ikke er skadet.







File holder disassembly and cleaning

Rastavljanje i čišćenje držača za igle

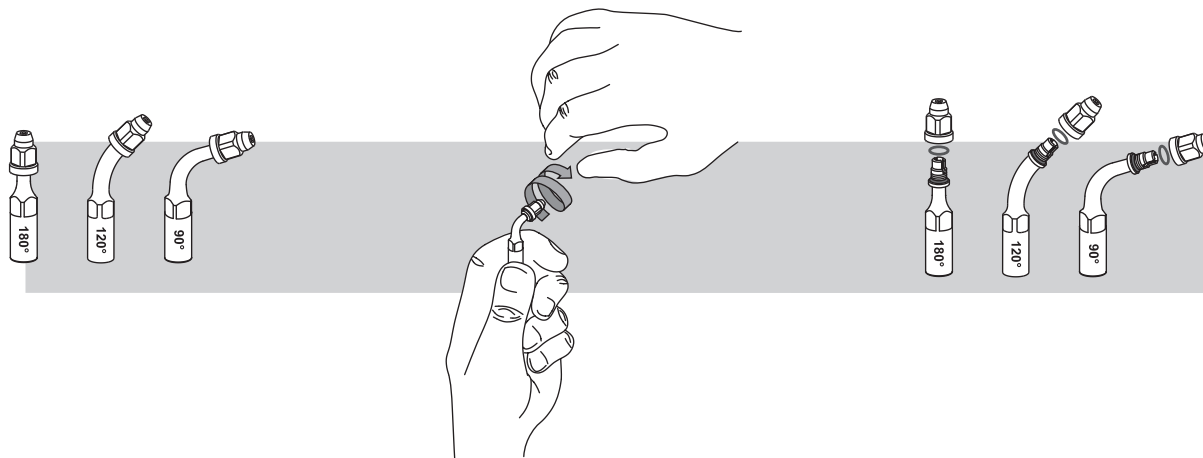
Demontage en reiniging vijlhouder





 Remove the tightening nut and the O-ring (when equipped) to clean each component under running water before disinfection.

 Please follow the recommendations of the Reprocessing Instructions manual delivered with your product regarding the procedures for cleaning, disinfecting, sterilizing and packing of the components.

 Regularly check that the O-ring on the file holder is not damaged.

 Odvrnite maticu i o-prsten (ako postoje) kako biste svaki dio očistili pod mlazom vode prije dezinfekcije.

 Molimo pridržavajte se uputa u svezi s čišćenjem, dezinfekcijom, sterilizacijom i pakiranjem komponenata u priručniku "Upute za reprocessiranje" koji je isporučen s vašim proizvodom.

 Redovito provjeravajte jesu li o-prstenovi nasadnika oštećeni.

 Verwijder de bevestigingsmoer en de O-ring (indien van toepassing) om elk onderdeel vóór desinfectie onder stromend water te reinigen.

 Houd u aan de aanbevelingen van de handleiding 'Instructies voor verwerking' die met uw product is meegeleverd, voor de procedures voor reiniging, desinfectie, sterilisatie en verpakking van de onderdelen.

 Controleer regelmatig of de O-ring van de vijlhouder niet beschadigd is.







Desmontagem e limpeza do porta-limas

Demontering og rengøring af filholder

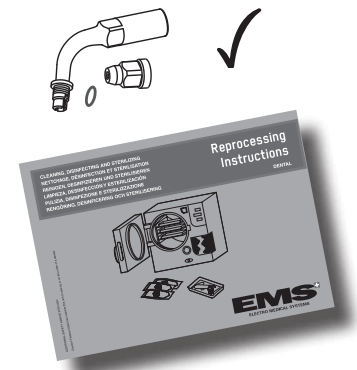
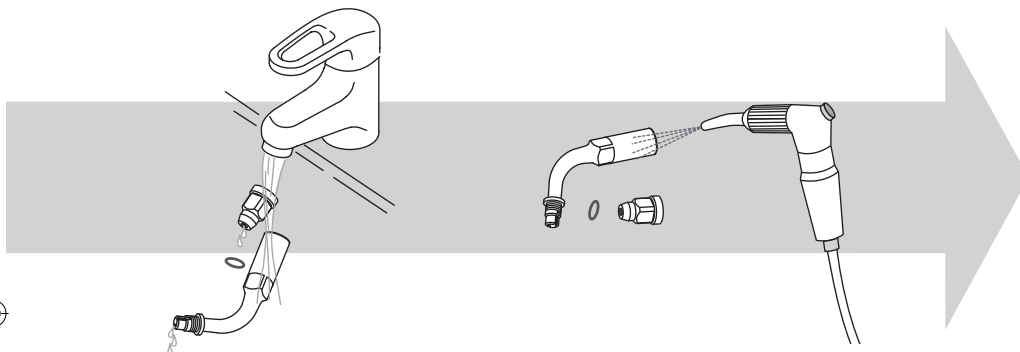
Demontering og rengjøring av filholderne





 Retire a porca de aperto e o O-ring (quando existir) para limpar cada componente em água corrente antes da desinfecção.

 Relativamente à limpeza, desinfecção, esterilização e embalagem dos componentes, deve respeitar todas as recomendações do manual de instruções de reprocessamento que acompanha o produto.

 Verifique regularmente se o O-ring do porta-limas não apresenta danos.

 Fjern spændemøtrikken og O-ringen (når den forefindes) for at rengøre hver komponent under rindende vand før desinficering.

 Følg anbefalingerne i vejledningen Instruktioner i genbehandling, der blev leveret sammen med dit produkt, vedrørende procedurerne for rengøring, desinficering, sterilisering og pakning af komponenterne.

 Kontroller regelmæssigt, at O-ringen på filholderen ikke er beskadiget.

 Fjern strammemutteren og O-ringen (hvis dette finnes) og rengjør hver del under rennende vann før desinfisering.

 Følg anbefalingene om rengjøring, desinfisering, sterilisering og emballering av delene i håndboken "Instruksjoner for behandling etter bruk" som følger med produktet.

 Kontroller jevnlig at O-ringen på filholderen ikke er skadet.







WEAR AND MAINTENANCE

KONTROLA I ODRŽAVANJE

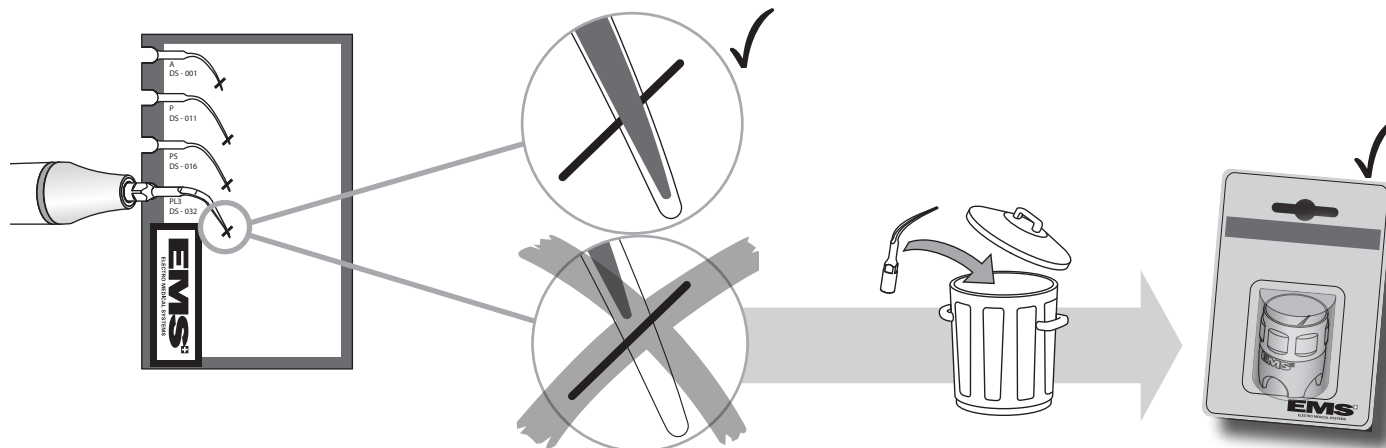
SLIJTAGE EN ONDERHOUD



The EMS Piezon instruments must be checked regularly using the EMS "Tip Card". Ultrasound instruments wear during use and become shorter. Worn instruments are ineffective and are a cause of discomfort to the patient.

 Instruments showing wear on the diamond coating must be replaced.

 For precautionary reasons, do not exceed the validated lifespan of the components (see the Technical Data chapter).

 Always use EMS original parts. Using non original components may damage the equipment, and practitioner or patient may be injured.

Instrumenti Piezon tvrtke EMS moraju se redovito provjeravati pomoću "kartice sa savjetima" tvrtke EMS. Ultrazvučni instrumenti troše se tijekom upotrebe i postaju kraći. Istrošeni instrumenti nisu učinkoviti i uzrokuju neugodu pacijentu.

 Instrumenti koji pokazuju znakove istrošenosti dijamantnog premaza moraju se zamijeniti.

 Zbog predostrožnosti nemojte koristiti komponente nakon dopuštenog vijeka upotrebe (pogledajte poglavlje Tehnički podaci).

 Uvijek koristite originalne dijelove tvrtke EMS. Upotrebom zamjenskih komponenti može se oštetiti opremu i ozlijediti liječnika ili pacijenta.

De EMS Piezon-instrumenten moeten regelmatig worden gecontroleerd aan de hand van de EMS "Tipkaart". Ultrasone instrumenten slijten tijdens gebruik en worden korter. Afgesleten instrumenten zijn ineffectief en zijn onaangenaam voor de patiënt.

 Instrumenten die slijtage vertonen op de diamantcoating, moeten worden vervangen.

 Uit voorzorg dient de gevalideerde levensduur van de onderdelen niet te worden overschreden (zie het hoofdstuk Technische gegevens).

 Gebruik altijd originele EMS-onderdelen. Het gebruik van niet originele onderdelen kan de apparatuur beschadigen en kan leiden tot letsel van behandelaar of patiënt.





DESGASTE E MANUTENÇÃO

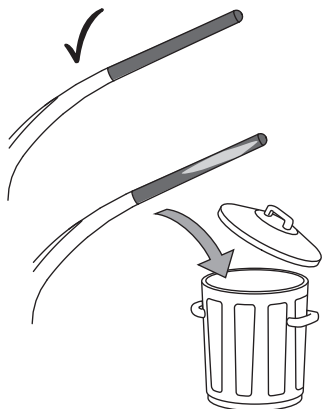

SLITAGE OG VEDLIGEHOLDELSE

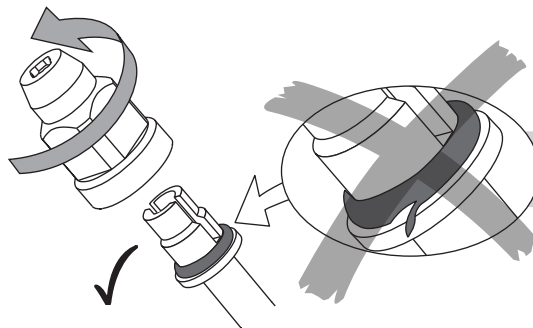

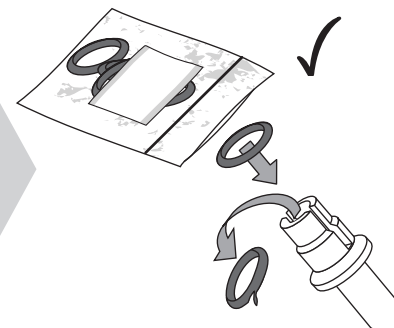

SLITASJE OG VEDLIKEHOLD



Os instrumentos EMS Piezon têm de ser verificados regularmente com o cartão EMS "Tip Card". Os instrumentos ultrassónicos desgastam-se durante a utilização e ficam mais curtos. Os instrumentos desgastados são ineficazes, dando origem a desconforto para o paciente.

 Os instrumentos que exibam sinais de desgaste no revestimento diamantado têm de ser substituídos.

 Por precaução, não ultrapasse o prazo de vida útil validado para os componentes (consulte o capítulo Dados Técnicos).

 Use sempre peças originais EMS. A utilização de componentes não originais pode danificar o equipamento e pode lesionar o profissional de saúde ou o paciente.

EMS Piezon-instrumenterne skal kontrolleres regelmæssigt ved brug af EMS-"tipkortet". Ultralydsinstrumenter slides under brug og bliver kortere. Slidte instrumenter er ineffektive og ubehagelige for patienten.

 Instrumenter, der viser tegn på slitage på diamantbelægningen, skal udskiftes.

 Overskrid af sikkerhedsmæssige årsager ikke komponenternes validerede levetid (se kapitlet Tekniske data).

 Anvend altid originale EMS-deler. Anvendelse af uoriginale komponenter kan beskadige udstyret og skade lægen eller patienten.

EMS Piezon-instrumentene må kontrolleres jevnlig ved bruk av EMS "Tip Card". Ultralydinstrumenter blir utsatt for slitasje under bruk og blir kortere. Slitte instrumenter er ineffektive og kan føre til ubehag for pasienten.

 Instrumenter med diamantbelegg som viser tegn på slitasje, må skiftes ut.

 Som en forholdsregel må delene ikke brukes etter endt levetid (se Tekniske data).

 Bruk alltid originale EMS-deler. Bruk av ikke-originale deler kan føre til skade på utstyret, tannlegen eller pasienten.







SAFETY PRECAUTIONS

EMS and the distributor of this product accept no liability for direct or consequential injury or damage resulting from improper use, arising in particular through non-observance of the operating instructions, or improper preparation and maintenance.

 Only use this product for the intended indications. Carefully read these operating instructions before using the product. This also applies to any product used with this system. Failure to observe the operating instructions may result in the patient or user suffering serious injury or the product being damaged.

 Do not use this product in the presence of inflammable anaesthetics or gases.

 This product must only be used by trained and qualified personnel.

 In rare cases the high frequency oscillations can break activated instruments or files, particularly when not manipulated properly. Place a rubber dam before treatment to prevent the patient from swallowing or inhaling parts of a fractured instrument, or a loose instrument. If a rubber dam cannot be placed, instruct the patient to breathe through the nose during treatment.

MJERE OPREZA

EMS i distributer ovog proizvoda ne prihvaćaju odgovornost za izravne ili posljedične ozljede ili štetu nastale neispravnim rukovanjem, a posebno ako je do njih došlo uslijed nepridržavanja uputa za rukovanje ili neispravne pripreme i održavanja.

 Ovaj proizvod koristite samo za indikacije za koje je namijenjen. Pažljivo pročitajte ove korisničke upute prije uporabe proizvoda. To se odnosi i na svu opremu koja se koristi s ovim sustavom. U slučaju nepridržavanja uputa za rukovanje postoji opasnost od ozbiljne ozljede pacijenta ili korisnika ili pak oštećenja proizvoda.

 Uređaj nemojte koristiti u blizini zapaljivih anestetika ili plinova.

 Ovaj proizvod smije koristiti samo obučeno i kvalificirano osoblje.

 U rijetkim slučajevima, visoka frekvencija oscilacija može slomiti aktivirane instrumente ili igle, posebno ako se njima ne rukuje na odgovarajući način. Prije tretmana postavite koferdam kako bi se spriječilo da pacijent proguta ili udahne dijelove slomljenog instrumenta ili labavi instrument. Ako se koferdam ne može postaviti, uputite pacijenta da za vrijeme tretmana diše kroz nos.

VOORZORGSMAATREGELEN VOOR DE VEILIGHEID

EMS en de leverancier van dit product aanvaarden geen aansprakelijkheid voor rechtstreeks letsel, gevolgtelsel of schade die het gevolg is van onjuist gebruik, met name door het zich niet houden aan de gebruiksaanwijzing of onjuiste voorbereiding en onderhoud.

 Gebruik dit product uitsluitend voor de bedoelde indicaties. Lees deze gebruiksaanwijzing zorgvuldig door voor u het product gebruikt. Dit geldt ook voor alle producten die met dit systeem worden gebruikt. Niet volgen van de gebruiksaanwijzing kan leiden tot ernstig letsel van de patiënt of gebruiker of tot beschadiging van het product.

 Gebruik dit product niet in de aanwezigheid van ontvlambare narcosemiddelen of gassen.

 Dit product mag uitsluitend worden gebruikt door speciaal opgeleid en gekwalificeerd personeel.

 In zeldzame gevallen kunnen door de hoogfrequente trillingen geactiveerde instrumenten of vijlen breken, met name wanneer ze niet goed worden gehanteerd. Plaats voor behandeling een rubberdam om te voorkomen dat de patiënt delen van een gebroken of losgeraakt instrument doorslikt of inhaleert. Instrueer de patiënt om tijdens de behandeling door de neus te ademen als er geen rubberdam kan worden geplaatst.







PRECAUÇÕES DE SEGURANÇA

A EMS e o distribuidor deste produto não se responsabilizam por lesões ou danos directos ou indirectos resultantes de uma utilização incorrecta, decorrentes em particular da inobservância das instruções de utilização ou de uma preparação e manutenção incorrectas.

 Use este produto apenas para as indicações previstas. Leia atentamente estas instruções de funcionamento antes de usar o produto. O mesmo se aplica a qualquer produto utilizado com este sistema. A inobservância das instruções de utilização pode resultar em lesões graves para o utilizador ou para o paciente ou em danos para o produto.

 Não utilize este produto na presença de gases ou anestésicos inflamáveis.

 Este produto apenas pode ser utilizado por pessoal qualificado e com formação.

 Em casos raros, as oscilações de alta frequência podem quebrar instrumentos ou limas activados, em particular quando não são manipulados de forma adequada. Coloque um dique de borracha antes do tratamento para evitar que o paciente engula ou inspire pedaços de um instrumento fracturado ou um instrumento solto. Se não for possível utilizar um dique de borracha, instrua o paciente para respirar pelo nariz durante o tratamento.

SIKKERHEDSFORANSTALTNINGER

EMS og forhandleren af dette produkt påtager sig ikke ansvar for direkte eller følgemæssige læsioner eller skader, der er forårsaget af forkert brug, som er sket på grund af manglende overholdelse af betjeningsinstruktionerne eller forkert klargøring og vedligeholdelse.

 Anvend kun dette produkt til de beregnede indikationer. Læs omhyggeligt disse betjeningsinstruktioner, før produktet tages i brug. Dette gælder også for ethvert produkt, der anvendes sammen med dette system. Manglende overholdelse af betjeningsinstruktionerne kan resultere i, at patienten eller brugeren kommer alvorligt til skade, eller at produktet beskadiges.

 Brug ikke dette produkt i nærheden af brændbare anæstetika eller gasser.

 Dette produkt må kun anvendes af uddannet og kvalificeret personale.

 I sjældne tilfælde kan højfrekvenssvingningerne knække aktiverede instrumenter eller filer, specielt når de håndteres forkert. Anbring en kofferdam før behandlingen for at forhindre patienten i at synke eller indånde dele af et knækket eller et løst instrument. Hvis der ikke kan anbringes en kofferdam, skal patienten instrueres i at trække vejret gennem næsen under behandlingen.

SIKKERHETSFORHOLDSREGLER

EMS og distributøren av dette produktet påtar seg intet ansvar for direkte eller påfølgende skade som skyldes feil bruk, manglende overholdelse av bruksanvisningen eller feil klargjøring og vedlikehold.

 Dette produktet må bare brukes til det det er indisert til. Les bruksanvisningen nøye før produktet tas i bruk. Dette gjelder også for alle produkter som brukes sammen med dette systemet. Hvis bruksanvisningen ikke følges, kan det føre til alvorlig skade på pasienten, brukeren eller produktet.

 Produktet må ikke brukes i nærheten av brannfarlige anestesimidler eller gasser.

 Produktet må kun brukes av kvalifisert personell som har fått opplæring i bruken av det.

 I sjeldne tilfeller kan de høyfrekvente svingningene føre til at aktiverte instrumenter eller filer brekker, spesielt hvis de ikke brukes på riktig måte. Legg inn en gummiduk før behandlingen for å hindre at pasienten svelger eller inhalerer deler av et brukket instrument eller et løst instrument. Hvis dette ikke kan brukes, må pasienten få beskjed om å puste gjennom nesen under behandlingen.





 To avoid heat damage on the tooth, never work dry unless the instrument is specifically designed and indicated as such. The tip of the activated instrument heats up immediately when used dry. The instrument must not be activated during more than 10% of a maximum working time of 10 minutes with the "Dry Work" function. An incorrect use may also cause a deterioration of the handpiece.

 Make sure to always sterilize handpieces and instruments before use. Non-sterile handpieces and instruments may cause bacterial or viral infections. Please follow the recommendations of the "Reprocessing Instructions" manual delivered with your product regarding the procedures for cleaning, disinfecting and sterilizing of the components.

 Always examine your Piezon system for damage before commencing treatment. Damaged accessories or a damaged product must not be used and must be replaced. Use original EMS spare parts and accessories only.

 Listen for a noise change when the instrument is activated to detect a possible loosening of the instrument in the handpiece. This also applies to file holders.

 Kako bi se izbjeglo oštećenje zuba zbog topline, nikad ne radite na suho osim ako je instrument posebno osmišljen i indiciran za takav rad. Vrh aktiviranog instrumenta odmah se zagrijava kada se koristi na suho. Instrument ne smije biti aktiviran duže od 10% maksimalnog vremena rada od 10 minuta s funkcijom rada na suho. Neispravna uporaba također može dovesti do oštećenja na nasadniku.

 Prije uporabe uvijek treba sterilizirati nasadnike i instrumente. Nesterilni nasadnici i instrumenti mogu prouzročiti bakterijske ili virusne infekcije. Molimo pridržavajte se uputa u svezi s postupcima čišćenja, dezinfekcije i sterilizacije komponenata u korisničkom priručniku "Upute za reprocesiranje" koji je isporučen s vašim proizvodom.

 Prije početka tretmana uvijek provjerite da vaš Piezon sustav nije oštećen. Oštećeni dodaci ili oštećeni proizvod ne smiju se koristiti i moraju se zamijeniti. Koristite samo originalne rezervne dijelove i dodatke tvrtke EMS.

 Slušajte promjenu u zvuku kad je igla aktivirana kako biste otkrili moguće otpuštanje igle ili instrumenta u držaču za igle. To se odnosi i na držače za igle.

 Voorkom beschadiging van gebitselementen door warmte: werk nooit droog tenzij het instrument hier speciaal voor is ontworpen en dit als zodanig is aangegeven. De tip van het geactiveerde instrument wordt bij droog gebruik onmiddellijk warm. Bij toepassing in de 'droge modus' mag het instrument niet langer dan 10% van de maximale werktijd van 10 minuten worden geactiveerd. Onjuist gebruik kan ook aantasting van het handstuk veroorzaken.

 Zorg dat u handstukken en instrumenten voor gebruik altijd steriliseert. Niet-steriele handstukken en instrumenten kunnen bacteriële of virale infecties veroorzaken. Houd u aan de aanbevelingen van de handleiding 'Instructies voor verwerking' die met uw product is meegeleverd, voor de procedures voor reiniging, desinfectie en sterilisatie van de onderdelen.

 Controleer uw Piezon-systeem altijd op beschadigingen voor u met een behandeling begint. Beschadigde toebehoren of een beschadigd product mogen niet worden gebruikt en moeten worden vervangen. Gebruik uitsluitend originele EMS-reserveonderdelen en -toebehoren.

 Wees bij een geactiveerd instrument alert op een verandering in geluid, aangezien dit kan betekenen dat een instrument is komen los te zitten in het handstuk. Dit is ook van toepassing op de vijlhouders.





 Para evitar danos no dente provocados por calor, nunca trabalhe sem irrigação, excepto quando o instrumento tiver sido concebido especificamente para esse fim e tiver essa indicação. A ponta do instrumento activado aquece imediatamente quando é usada a seco. O instrumento não pode ser utilizado na função "Dry Work" durante mais de 10% de um período máximo de funcionamento de 10 minutos. Uma utilização incorrecta pode ainda causar uma deterioração da peça de mão.

 Assegure-se de que esteriliza sempre as peças de mão e os instrumentos antes de utilizar. As peças de mão e os instrumentos não esterilizados podem causar infecções virais ou bacterianas. Relativamente à limpeza, desinfecção, esterilização dos componentes, deve respeitar todas as recomendações do manual de "Instruções de reprocessamento" que acompanha o produto.

 Examine sempre a existência de danos no sistema Piezon antes de iniciar o tratamento. Os acessórios ou produtos danificados não podem ser utilizados e têm de ser substituídos. Use apenas acessórios e peças sobresselentes originais da EMS.

 Esteja atento a quaisquer alterações no ruído quando o instrumento é activado, de modo a detectar afrouxamento na fixação do instrumento à peça de mão. O mesmo se aplica aos porta-limas.

 For at undgå at varmebeskadige tanden må du ikke arbejde tørt, medmindre instrumentet er specialdesignet og indiceret til dette. Spidsen på det aktiverede instrument ophedes omgående, når den anvendes i tør tilstand. Instrumentet må ikke aktiveres i mere end 10 % af den maksimale arbejdstid på 10 minutter med funktionen "Tørarbejde". Forkert brug kan også forårsage en forringelse af håndstykket.

 Sørg for altid at sterilisere håndstykkerne og instrumenterne før brug. Usterile håndstykker og instrumenter kan forårsage bakterie- eller virusinfektioner. Følg anbefalingerne i vejledningen "Instruktioner i genbehandling", der blev leveret sammen med dit produkt, vedrørende procedurerne for rengøring, desinficering og sterilisering af komponenterne.

 Undersøg altid, om Piezon-systemet er beskadiget, før behandlingen påbegyndes. Beskadiget tilbehør eller et beskadiget produkt må ikke bruges og skal udskiftes. Anvend kun originale EMS-reservedele og tilbehør.

 Lyt efter støjændringer, når instrumentet er aktiveret, for at bemærke om instrumentet eventuelt skulle sidde løst i håndstykket. Dette gælder også for filholdere.

 For å hindre varmeindusert skade på tannen må du aldri arbeide "tørt" med mindre instrumentet er spesielt utformet og indisert til dette. Spissen på det aktiverede instrumentet blir umiddelbart varm når den brukes "tørt". Instrumentet må ikke aktiveres i mer enn 10 % av en maksimal arbeidstid på 10 minutter med funksjonen "Dry Work". Feil bruk kan også føre til at håndstykket går i stykker.

 Håndstykkene og instrumentene må alltid steriliseres før bruk. Ikke-sterile håndstykker og instrumenter kan forårsake bakterie- eller virusinfeksjoner. Følg anbefalingene om rengjøring, desinfisering og sterilisering av delene i håndboken "Instruksjoner for behandling etter bruk" som følger med produktet.

 Før behandlingen starter, må Piezon-systemet alltid undersøkes med tanke på skade. Skadet tilbehør eller skadede produkter må ikke brukes og må skiftes ut. Bruk kun originale reservedeler og originalt tilbehør fra EMS.

 Lytt etter forandringer i lyden når instrumentet aktiveres for å oppdage om instrumentet har løsnet i håndstykket. Dette gjelder også filholdere.



STORING THE PRODUCT

SKLADIŠTENJE PROIZVODA

OPBERGEN VAN HET PRODUCT

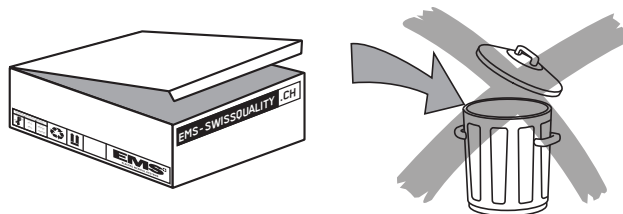

 Keep the original packaging until the product is to be disposed of permanently. It can be used for shipping or storing at any time.

Should you wish to store the product for an extended period of time:

- Proceed as described in the "Cleaning, disinfecting and sterilizing" chapter,
- Pack the product and all accessories in the original packaging.

Please refer to the storage and transport conditions in the "Technical data" section.

 Originalno pakiranje čuvajte sve dok proizvod ne odložite na otpad. Možete ga koristiti za slanje ili skladištenje u bilo kojem trenutku.

Ako proizvod želite skladištiti na duže vrijeme:

- postupite prema uputama opisanim u poglavlju "Čišćenje, dezinfekcija i sterilizacija",
- proizvod i sve dodatke zapakirajte u originalno pakiranje.

U odjeljku "Tehnički podaci" pogledajte uvjete za skladištenje i prijevoz.

 Bewaar de oorspronkelijke verpakking tot het product definitief moet worden afgevoerd. De verpakking kan altijd worden gebruikt voor transport of opbergen.

Mocht u het product voor langere tijd willen opbergen:

- ga dan te werk zoals beschreven in het hoofdstuk 'Reinigen, desinfecteren en steriliseren';
- verpak het product en alle toebehoren in de oorspronkelijke verpakking.

Raadpleeg het hoofdstuk 'Technische gegevens' voor de omstandigheden voor bewaren en transport.







ARMAZENAMENTO DO PRODUTO

OPBEVARING AF PRODUKTET

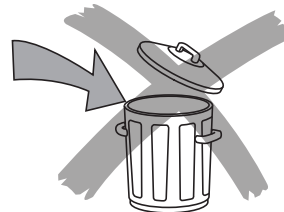
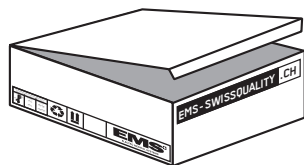
OPPBEVARING AV PRODUKTET



 Conserve a embalagem original até o produto ser definitivamente eliminado. Pode usá-la em qualquer altura para o transporte ou armazenamento do equipamento.

Se pretender guardar o produto por um período prolongado de tempo:

- proceda como se descreve no capítulo "Limpeza, desinfecção e esterilização",
- embale o produto e todos os acessórios na embalagem original.

Consulte as condições de armazenamento e transporte referidas na secção "Dados técnicos".

 Bevar den oprindelige pakning, indtil produktet skal bortskaffes permanent. Den kan når som helst bruges til forsendelse eller opbevaring.

Hvis du ønsker at tage dit produkt ud af brug i en længere periode:

- Gør som beskrevet i kapitlet "Rengøring, desinficering og sterilisering"
- Pak produktet og alt tilbehør i originalemballagen.

Se opbevarings- og transportbetingelserne i afsnittet "Tekniske data".

 Ta vare på originalemballasjen helt til produktet skal kasseres for godt. Den kan brukes til forsendelse eller oppbevaring.

Hvis produktet skal oppbevares i lengre tid:

- Følg fremgangsmåten under Rengjøring, desinfisering og sterilisering.
- Legg produktet og alt tilbehør i originalemballasjen.

Se Tekniske data for å få informasjon om oppbevaring og transport.





PRODUCT DISPOSAL

The product must not be discarded in domestic household waste. Should you wish to definitively dispose of the product, please comply with the regulations which apply in your country.

Waste Electrical and Electronic Equipment belonging to customers located in the European Union may be shipped to EMS for recycling in accordance to the WEEE regulations. The costs of recycling, exclusive of shipping fees, are covered by EMS.

WARRANTY

Damage due to non-adherence to the operating instructions or wear out of parts are excluded from warranty.

ACCESSORIES

Accessories are available from EMS or any authorized dealers. Please contact your customer service directly.

 For safety reasons this product may only be used with genuine EMS accessories. The user assumes all risks of using this product with non-genuine accessories or accessories which are not compliant with the operating instructions.

ODLAGANJE PROIZVODA NA OTPAD

Proizvod se ne smije baciti u običan kućanski otpad. Ako proizvod želite nepovratno odložiti na otpad, pridržavajte se propisa primjenjivih u vašoj zemlji.

Električni i elektronički otpad u vlasništvu korisnika koji se nalaze u Europskoj uniji može se poslati tvrtki EMS koja će ga reciklirati u skladu s propisima direktive WEEE. EMS pokriva troškove recikliranja, ali ne i troškove dopreme.

JAMSTVO

Oštećenja nastala zbog nepridržavanja uputa za rukovanje ili istrošeni dijelovi nisu pokriveni jamstvom.

DODACI

Dotatke je moguće nabaviti kod tvrtke EMS ili ovlaštenih distributera. Molimo obratite se izravno službi za korisnike tvrtke.

 Iz sigurnosnih razloga, ovaj proizvod smije se koristiti samo s originalnim EMS dodacima. Korisnik preuzima sav rizik od korištenja ovog proizvoda sa zamjenskim dodacima ili dodacima koji nisu sukladni korisničkim uputama.

AFVOEREN VAN HET PRODUCT

Het product mag niet worden weggegooid met het huishoudelijke afval. Mocht u het product definitief willen afvoeren, houdt u zich dan aan de daarvoor geldende voorschriften in uw land.

Overtollige elektrische en elektronische apparatuur van klanten in de Europese Unie kunnen worden verzonden naar EMS voor recycling overeenkomstig de WEEE-richtlijn. De kosten voor recycling, met uitzondering van de transportkosten, komen voor rekening van EMS.

GARANTIE

Schade als gevolg van het zich niet houden aan de gebruiksaanwijzing of slijtage van onderdelen valt niet onder de garantie.

TOEBEHOREN

Toebehoren zijn verkrijgbaar bij EMS of bevoegde leveranciers. Neem rechtstreeks contact op met uw consumentenservice.

 Om veiligheidsredenen mag dit product uitsluitend worden gebruikt met originele EMS-toebehoren. De gebruiker neemt alle risico's op zich bij gebruik van dit product met niet-originele toebehoren of toebehoren die niet overeenkomen met die in de gebruiksaanwijzing.





ELIMINAÇÃO DO PRODUTO

O produto não pode ser eliminado através da rede de eliminação de resíduos domésticos. Se pretender eliminar definitivamente o produto, cumpra a regulamentação em vigor no seu país.

O equipamento eléctrico e electrónico dos clientes destinado a eliminação e localizado dentro da União Europeia pode ser enviado à EMS para reciclagem, nos termos da norma REEE. Os custos da reciclagem, à excepção dos custos de envio, são cobertos pela EMS.

GARANTIA

Os danos provocados por inobservância das instruções de utilização ou desgaste das peças estão excluídos da garantia.

ACESSÓRIOS

Os acessórios podem ser adquiridos à EMS ou a um revendedor autorizado. Contacte directamente o seu serviço de assistência ao cliente.

 Por motivos de segurança, este produto apenas pode ser utilizado com acessórios originais da EMS. O utilizador assume todos os riscos decorrentes da utilização deste produto com acessórios de outras proveniências ou que não cumpram as indicações do manual de instruções.

BORTSKAFFELSE AF PRODUKT

Produktet må ikke bortskaffes via husholdningsaffald. Hvis du ønsker at bortskaffe produktet definitivt, skal du overholde de bestemmelser, der gælder i dit land.

Affald af elektrisk og elektronisk udstyr (Waste Electrical and Electronic Equipment), der tilhører kunden, som bor i EU, kan sendes til EMS for at blive genbrugt i overensstemmelse med WEEE-bestemmelserne. Omkostningerne for genbrug, eksklusivt forsendelsesgebyr, dækkes af EMS.

GARANTI

Beskadigelse, der skyldes manglende overholdelse af betjeningsinstruktionerne eller slidte dele, dækkes ikke af garantien.

TILBEHØR

Tilbehør kan købes hos EMS og alle godkendte forhandlere. Kontakt venligst kundeservice direkte.

 Af sikkerhedsgrunde må dette produkt kun anvendes sammen med originalt EMS-tilbehør. Brugeren påtager sig hele risikoen ved at bruge dette produkt sammen med uoriginalt tilbehør eller tilbehør, som ikke er i overensstemmelse med betjeningsinstruktionerne.

KASSERING AV PRODUKTET

Produktet må ikke kasseres sammen med husholdningsavfall. Følg gjeldende bestemmelser i ditt land når produktet skal kasseres for godt.

Elektrisk og elektronisk utstyr som tilhører kunder i EU, kan sendes til EMS for gjenvinning i henhold til bestemmelsene i WEEE-direktivet. Kostnadene for gjenvinning, ekskl. forsendelseskostnader, dekkes av EMS.

GARANTI

Skader som skyldes manglende overholdelse av bruksanvisningen eller slitasje på delene, dekkes ikke av garantien.

TILBEHØR

Tilbehør fås fra EMS eller EMS' autoriserte forhandlere. Kontakt kundetjenesten direkte.

 Av sikkerhetshensyn må dette produktet bare brukes sammen med originalt tilbehør fra EMS. Brukeren påtar seg alt ansvar ved bruk av produktet sammen med ikke-originalt tilbehør eller tilbehør som ikke er kompatibel med bruksanvisningen.







EMS CUSTOMER SERVICE

Please contact your dealer or EMS repair center for any servicing or repairs.

EMS decline responsibility for the safety of the device and declare the warranty null and void if servicing or repairs are carried out by an unauthorized third party or if non-genuine spare parts are used.

It is best to ship your product in the original packaging. It protects your product against damage during shipment.

 Before dispatching your product including all accessories, please clean, disinfect and sterilize them as described in the operating instructions.

 Risk of transmitting micro-organisms! To protect the personnel of the repair center and for safety reasons during transport and shipment, the product and the accessories returned to the factory for repair or revision must be cleaned, disinfected and sterilized in accordance with the operating manual. Repair can be refused for product or accessories received in a contaminated condition.

When sending your product directly to an approved EMS repair center, please include the name of the dealer to simplify processing.

ODJEL ZA KORISNIKE TVRTKE EMS

Molimo obratite se svom distributeru ili EMS servisu za servisiranje ili popravke.

EMS nije odgovoran za sigurnost uređaja i poništava jamstvo ako servisiranje i popravke obavlja neovlaštena treća strana ili ako se koriste zamjenski rezervni dijelovi.

Najbolje je da proizvod pošaljete u originalnom pakiranju. Ono će proizvod tijekom isporuke zaštititi od oštećenja.

 Prije slanja proizvoda i svih dodataka, molimo da ih očistite, dezinficirate i sterilizirate prema uputama opisanim u uputama za rukovanje.

 Rizik od prijenosa mikroorganizama! Da bi se zaštitilo osoblje centra za popravke i zbog sigurnosnih razloga tijekom prijevoza i slanja poštom, proizvod i dodaci koji se vraćaju u tvornicu na popravak ili pregled moraju se očistiti, dezinficirati i sterilizirati u skladu s uputama iz korisničkog priručnika. Proizvod i dodaci koji su zaprimljeni u kontaminiranom stanju neće se popravljati.

Prilikom slanja proizvoda izravno ovlaštenom centru za popravke tvrtke EMS navedite naziv vašeg dobavljača kako bismo pojednostavili proceduru.

EMS-KLANTENSERVICE

Neem contact op met uw leverancier of EMS-reparatiecentrum voor onderhoud of reparaties.

EMS aanvaardt geen verantwoordelijkheid voor de veiligheid van het hulpmiddel en verklaart de garantie ongeldig als onderhoud of reparaties worden uitgevoerd door een niet-erkende derde partij of als niet-originele reserveonderdelen worden gebruikt.

U kunt het product het best in de oorspronkelijke verpakking verzenden. Dit beschermt uw product tegen transportschade.

 Gelieve uw product inclusief alle toebehoren voor verzending te reinigen, desinfecteren en steriliseren zoals beschreven in de gebruiksaanwijzing.

 Risico van overdracht van micro-organismen! Om het personeel van het reparatiecentrum te beschermen en omwille van veiligheidsredenen tijdens transport en verzending, moeten het product en de toebehoren die voor reparatie of revisie naar de fabriek worden geretourneerd, worden gereinigd, gedesinfecteerd en gesteriliseerd zoals beschreven in de gebruikshandleiding. Reparatie kan worden geweigerd wanneer een product of toebehoren in vervuilde toestand wordt ontvangen.

Wanneer u uw product rechtstreeks naar een erkend EMS-reparatiecentrum stuurt, vermeld dan de naam van de leverancier voor gemakkelijker verwerking.





APOIO AO CLIENTE DA EMS

Para qualquer reparação ou manutenção, é favor contactar o seu distribuidor ou um centro de reparação da EMS.

A EMS recusa qualquer responsabilidade pela segurança do dispositivo e declara a nulidade da garantia se a reparação ou a manutenção for efectuada por terceiros não autorizados ou se forem utilizadas peças sobresselentes não originais da EMS.

É aconselhável enviar o seu produto na embalagem original. Esta protege o seu produto contra danos durante o envio.

 Antes de despachar o produto e todos os acessórios, limpe-os, desinfecte-os e esterilize-os como se descreve nas instruções de utilização.

 Risco de transmissão de microrganismos! Para proteger o pessoal do centro de reparação e por motivos de segurança durante o transporte e envio, o produto e os acessórios devolvidos à fábrica para reparação ou revisão têm de ser limpos, desinfectados e esterilizados, segundo as indicações do respectivo manual de instruções. A reparação de um produto ou acessórios pode ser recusada caso estes sejam recebidos em condições de contaminação.

Ao enviar o seu produto directamente para um centro de reparação aprovado pela EMS, inclua o nome do seu revendedor para simplificar o processamento.

EMS-KUNDESERVICE

Kontakt din forhandler eller EMS-reparationscenteret vedrørende servicering eller reparationer.

EMS påtager sig ikke ansvar for sikkerheden af anordningen og erklærer garantien for ugyldig, hvis der udføres service eller reparationer af en uautoriseret tredjepart, eller hvis der anvendes uoriginale reservedele.

Det er bedst at fremsende dit produkt i originalemballagen. Den beskytter dit produkt mod skader under forsendelsen.

 Før afsendelse af dit produkt med alt tilbehør, så rengør, desinficer og steriliser som beskrevet i betjeningsinstruktionerne.

 Risiko for overførsel af mikroorganismer! For at beskytte personalet på reparationscenteret og af sikkerhedsgrunde under transport og forsendelse skal det produkt og det tilbehør, der returneres til fabrikken for at blive repareret og eftersat, rengøres, desinficeres og steriliseres i overensstemmelse med betjeningsvejledningen. Reparation af produkter eller tilbehør, der modtages i en kontamineret tilstand, kan afvises.

Når du sender dit produkt direkte til et godkendt EMS-reparationscenter, bedes du medsende navnet på forhandleren for at forenkle behandlingen.

EMS' KUNDETJENESTE

Kontakt forhandleren eller EMS' reparasjonssenter ved behov for service eller reparasjon.

EMS frasier seg alt ansvar for utstyrets sikkerhet og erklærer garantien for ugyldig hvis service eller reparasjoner utføres av en ikke-godkjent tredjepart eller hvis ikke-originale reservedeler brukes.

Produktet bør sendes i originalemballasjen. Den beskytter produktet mot skade under forsendelsen.

 Før produktet, inkludert alt tilbehør, sendes, må det rengjøres, desinfiseres og steriliseres i henhold til fremgangsmåten i bruksanvisningen.

 Fare for overføring av mikroorganismer! For å beskytte de ansatte på reparasjonssenteret og av sikkerhetshensyn under transport og forsendelse må produktet og tilbehøret som sendes tilbake til fabrikken for reparasjon eller revisjon, rengjøres, desinfiseres og steriliseres i henhold til fremgangsmåten i bruksanvisningen. Reparasjonen kan avvises hvis produktene eller tilbehøret som mottas, er kontaminert.

Hvis produktet sendes direkte til et av EMS' godkjente reparasjonssentre, må navnet på forhandleren legges ved for å forenkle prosedyren.





SYMBOLS





SIMBOLI

SYMBOLEN

SÍMBOLOS

SYMBOLER

SYMBOLER

	<p>Manufacturer's logo Logotip proizvođača Fabrikantlogo Logótipo do fabricante Producentens logo Produsentens logo</p>
	<p>Sterilizable at up to 135 °C Moguće sterilizirati do 135 °C Steriliseerbaar tot 135 °C Esterilizável até 135 °C Kan steriliseres ved op til 135 °C Kan steriliseres ved opptil 135 °C</p>
	<p>Caution! Oprez! Waarschuwing! Atenção! Forsigtig! OBS!</p>
	<p>CE symbol: refers to directive 93/42 EEC, including EN 60601-1 and EN 60601-1-2 CE oznaka: odnosi se na direktivu 93/42 EEZ, uključujući EN 60601-1 i EN 60601-1-2 CE-markering: verwijst naar richtlijn 93/42 EEG, inclusief EN 60601-1 en EN 60601-1-2 Símbolo CE: refere-se à directiva 93/42 CEE, incluindo a EN 60601-1 e a EN 60601-1-2 CE-symbol: refererer til direktiv 93/42 EEC, inklusive EN 60601-1 og EN 60601-1-2 CE-symbol: Henviser til direktiv 93/42 EØF, inkludert EN 60601-1 og EN 60601-1-2</p>





TECHNICAL DATA

Description

Manufacturer	EMS Electro Medical Systems SA CH-1260 Nyon, Switzerland
Model	Piezon® Instruments and Systems
Classification 93/42 EEC	Class IIa
Operating conditions	+10 °C to +40 °C 30% to 75% relative humidity
Storage and transport conditions	-10 °C to +40 °C 10% to 95% relative humidity 500 hPa to 1060 hPa air pressure
Validated life span: - Instruments and CombiTorques - SystemBoxes - Handpieces	100 sterilization cycles 2000 sterilization cycles 1000 sterilization cycles (in autoclave at 135°C)

TEHNIČKI PODACI

Opis

Proizvođač	EMS Electro Medical Systems SA CH-1260 Nyon, Switzerland
Model	Piezon® Instrumenti i sustavi
Klasifikacija 93/42 EEZ	Klasa IIa
Radni uvjeti	+10 °C do +40 °C 30% do 75% relativne vlažnosti zraka
Uvjeti skladištenja i prijevoza	- 10 °C do +40 °C 10% do 95% relativne vlažnosti zraka tlak zraka od 500 hPa do 1060 hPa
Potvrđeni životni vijek: - Instrumenti i kombinirani ključevi (CombiTorque) - SystemBoxes - Nasadnici	100 ciklusa sterilizacije 2000 ciklusa sterilizacije 1000 ciklusa sterilizacije (u autoklavu na 135°C)



TECHNISCHE GEGEVENS

Omschrijving

Fabrikant	EMS Electro Medical Systems SA CH-1260 Nyon, Zwitserland
Model	Piezon®-instrumenten en -systemen
Classificatie 93/42 EEG	Klasse IIa
Gebruiksomstandigheden	+10 °C tot +40 °C 30% tot 75% relatieve vochtigheid
Omstandigheden voor opslag en transport	-10 °C tot +40 °C 10% tot 95% relatieve vochtigheid 500 hPa tot 1060 hPa luchtdruk
Gevalideerde levensduur: - Instrumenten en CombiTorques - SystemBox - Handstukken	100 sterilisatiecycli 2000 sterilisatiecycli 1000 sterilisatiecycli (in autoclaaf bij 135 °C)

DADOS TÉCNICOS

Descrição

Fabricante	EMS Electro Medical Systems SA CH-1260 Nyon, Suíça
Modelo	Instrumentos e sistemas Piezon®
Classificação 93/42 CEE	Classe IIa
Condições de funcionamento	+10 °C a +40 °C 30% a 75% de humidade relativa
Condições de armazenamento e transporte	-10 °C a +40 °C 10% a 95% de humidade relativa 500 hPa a 1060 hPa de pressão atmosférica
Tempo de vida útil validado: - Instrumentos e CombiTorques - SystemBoxes - Peças de mão	100 ciclos de esterilização 2000 ciclos de esterilização 1000 ciclos de esterilização (em autoclave a 135 °C)



TEKNISKE DATA

Beskrivelse

Producent	EMS Electro Medical Systems SA CH-1260 Nyon, Schweiz
Model	Piezon® instrumenter og systemer
Klassifikation 93/42 EEC	Klasse IIa
Driftsforhold	+10 °C til +40 °C 30 % til 75 % relativ fugtighed
Opbevarings- og transportforhold	-10 °C til +40 °C 10 % til 95 % relativ fugtighed Luftryk 500 hPa til 1060 hPa
Valideret levetid: - Instrumenter og CombiTorques - SystemBoxes - Håndstykker	100 steriliseringscykluser 2000 steriliseringscykluser 1000 steriliseringscykluser (i autoklave ved 135 °C)

TEKNISKE DATA

Beskrivelse

Produsent	EMS Electro Medical Systems SA CH-1260 Nyon, Sveits
Modell	Piezon®-instrumenter og -systemer
Klassifisering 93/42 EØF	Klasse IIa
Bruksforhold	+10–40 °C 30–75 % relativ fuktighet
Temperatur- og oppbevaringsforhold	-10–+40 °C 10–95 % relativ fuktighet 500–1060 hPa lufttrykk
Validert levetid: - Instrumenter og CombiTorques - SystemBoxes - Håndstykker	100 steriliseringscykluser 2000 steriliseringscykluser 1000 steriliseringscykluser (i autoklav ved 135 °C)



TROUBLESHOOTING

Symptom	Solution
No or low irrigation flow	<ul style="list-style-type: none">• Check if the instrument is blocked. Blow compressed air through the instrument to unblock it• Use another handpiece to check if the handpiece is blocked• If the obstruction cannot be removed, the handpiece must be sent to an approved EMS repair center• Please refer to the operation instructions of the Piezon unit for more details
No ultrasound oscillations	<ul style="list-style-type: none">• Please refer to the operation instructions of the Piezon unit
Decreasing or reduced performance	<ul style="list-style-type: none">• Follow the instructions found in the operation instructions of the Piezon unit• Make sure that the instrument is properly positioned, tighten it again with the CombiTorque• Check the instrument for wear and replace it if needed• Try to use the handpiece with another instrument• Send the handpiece and the instrument to an approved EMS repair center
Breakage of a file or instrument, possibly inside the cavity or the root canal	<ul style="list-style-type: none">• Make sure that every broken part is located• Compare total length of the broken parts with the length of a new file or instrument to make sure that all broken parts are present• Try to remove broken parts inside the root canal by activating maximum irrigation (no ultrasound) on a file to attempt to force the debris out• Refer to instructions and use the RT2, RT3 and RT4 instruments that are specially designed for this application
Diamond-coated instruments become less effective	<ul style="list-style-type: none">• Visually check the condition of the diamond coating and replace the instrument if needed





OTKLANJANJE POTEŠKOĆA

Simptom	Rješenje
Bez mlaza za ispiranje ili sa slabim mlazom	<ul style="list-style-type: none">• Provjerite je li instrument blokiran Upušite komprimirani zrak kroz instrument kako biste ga odblokirali• Upotrijebite drugi nasadnik kako biste provjerili je li nasadnik blokiran• Ako začepljenje ne izlazi iz ručne jedinice, pošaljite je u ovlaštenu centar za popravke tvrtke EMS• Za više informacija, molimo pogledajte korisničke upute Piezon jedinice
Nema oscilacija ultrazvuka	<ul style="list-style-type: none">• U uputama za rukovanje potražite više informacija.
Pad ili smanjena performansa	<ul style="list-style-type: none">• Slijedite upute u korisničkom priručniku Piezon jedinice• Provjerite je li instrument u ispravnom položaju, stegnite ga ponovno pomoću kombiniranog ključa (CombiTorque)• Provjerite je li instrument istrošen i ako je potrebno zamijenite ga• Pokušajte koristiti nasadnik s drugim instrumentom• Pošaljite nasadnik i instrument ovlaštenom centru za popravke tvrtke EMS
Slomljena igla ili instrument, moguće unutar šupljine ili korijenskog kanala	<ul style="list-style-type: none">• Provjerite jeste li pronašli sve slomljene dijelove• Usporedite ukupnu duljinu slomljenih dijelova s duljinom nove igle ili instrumenta kako biste bili sigurni da imate sve slomljene dijelove• Pokušajte ukloniti slomljene dijelove unutar korijenskog kanala aktiviranjem maksimalnog ispiranja (bez ultrazvuka) na iglu kako biste pokušali izgurati krhotinu.• Pogledajte upute i koristite instrumente RT2, RT3 i RT4 namijenjene za tu primjenu
Dijamantno presvučeni instrumenti postaju manje učinkoviti	<ul style="list-style-type: none">• Vizualno provjerite stanje dijamantnog premaza i ako treba zamijenite instrument



PROBLEEMOPLOSSING

Verschijnsel	Oplossing
Geen of weinig irrigatie	<ul style="list-style-type: none">• Controleer of het instrument wordt geblokkeerd. Blaas perslucht door het instrument om de blokkering op te heffen• Gebruik een ander handstuk om te controleren of het handstuk wordt geblokkeerd• Als de obstructie niet kan worden opgeheven, moet het handstuk naar een erkend EMS-reparatiecentrum worden gestuurd• Zie de bedieningsinstructies van het Piezon-apparaat voor verdere bijzonderheden
Geen ultrasone trillingen	<ul style="list-style-type: none">• Zie de bedieningsinstructies van het Piezon-apparaat
Afnemende of verminderde werking	<ul style="list-style-type: none">• Volg de instructies op in de bedieningsinstructies van het Piezon-apparaat• Zorg dat het instrument goed is geplaatst, draai het nogmaals vast met de CombiTorque• Controleer het instrument op slijtage en vervang het zo nodig• Probeer het handstuk met een ander instrument• Stuur het handstuk en het instrument naar een erkend EMS-reparatiecentrum
Afbreken van een vijl of instrument, mogelijk in de caviteit of het wortelkanaal	<ul style="list-style-type: none">• Zorg dat elk afgebroken deel wordt gelokaliseerd• Vergelijk de totale lengte van de afgebroken delen met de lengte van een nieuwe vijl of instrument om zeker te zijn dat alle afgebroken delen zijn verwijderd• Probeer de afgebroken delen uit het wortelkanaal te verwijderen door activering van maximale irrigatie (geen ultrageluid) op een vijl om het débris naar buiten te spoelen• Zie de instructies en gebruik de instrumenten RT2, RT3 en RT4 die speciaal voor deze toepassing zijn ontworpen
Diamantinstrumenten worden minder effectief	<ul style="list-style-type: none">• Controleer visueel de conditie van de diamantcoating en vervang het instrument zo nodig



RESOLUÇÃO DE PROBLEMAS

Sintoma	Solução
Sem caudal de irrigação ou com caudal reduzido	<ul style="list-style-type: none">• Verifique se o instrumento está entupido. Aplique um jacto de ar comprimido através do instrumento para o desentupir• Use outra peça de mão para verificar se a peça de mão está entupida• Se não for possível remover a obstrução, a peça de mão tem de ser enviada a um centro de reparações aprovado pela EMS• Consulte as instruções de utilização da unidade Piezon para mais pormenores.
Sem oscilações ultrassónicas	<ul style="list-style-type: none">• Consulte as instruções de utilização da unidade Piezon
Eficácia decrescente ou reduzida	<ul style="list-style-type: none">• Siga as indicações das instruções de utilização da unidade Piezon• Assegure-se de que o instrumento está devidamente posicionado e aperte-o de novo com o CombiTorque• Verifique o desgaste do instrumento e substitua-o, se necessário• Tente usar a peça de mão com outro instrumento• Envie a peça de mão e o instrumento a um centro de reparações aprovado pela EMS
Quebra de uma lima ou instrumento, possivelmente no interior da cavidade ou do canal radicular	<ul style="list-style-type: none">• Assegure-se de que localiza todas as partes da peça quebrada• Compare o comprimento total das peças quebradas com o comprimento de uma lima ou instrumento novo para assegurar de que localizou todas as partes da peça quebrada• Tente remover os pedaços da peça quebrada do interior do canal radicular activando a irrigação de uma lima no nível máximo (sem ultrassons) para tentar forçar a saída dos detritos• Consulte as instruções e utilize os instrumentos RT2, RT3 e RT4 especialmente concebidos para esta aplicação
Os instrumentos diamantados perdem a eficácia	<ul style="list-style-type: none">• Verifique visualmente o estado do revestimento diamantado e substitua o instrumento se necessário



FEJLFINDING

Symptom

Løsning

Ingen eller lav skyllegennemstrømning

- Kontroller, om instrumentet er blokeret. Blæs komprimeret luft gennem instrumentet for at fjerne blokeringen
- Anvend et andet håndstykke for at kontrollere, om håndstykket er blokeret
- Hvis obstruktionen ikke kan fjernes, skal håndstykket sendes til et godkendt EMS-reparationscenter
- Se Piezon-enhedens betjeningsinstruktioner for at få flere oplysninger

Ingen ultralydsvingninger

- Se Piezon-enhedens betjeningsinstruktioner

Faldende eller nedsat ydeevne

- Følg anvisningerne i Piezon-enhedens betjeningsinstruktioner
- Kontroller, at instrumentet er anbragt korrekt, og stram det igen med CombiTorque
- Kontroller, om instrumentet er slidt, og udskift det, hvis det er nødvendigt
- Forsøg at anvende håndstykket med et andet instrument
- Send håndstykket og instrumentet til et godkendt EMS-reparationscenter

Fil eller instrument knækket, muligvis inden i rodkanalens kavitet

- Sørg for at finde hver knækket del
- Sammenlign de knækkede deles samlede længde med længden på en ny fil eller et nyt instrument for at være sikker på, at alle knækkede dele forefindes
- Forsøg at fjerne knækkede dele inden i rodkanalen ved at aktivere maksimal skylning (ingen ultralyd) på en fil for at prøve at tvinge debris'en ud
- Se instruktionerne, og brug instrumenterne RT2, RT3 og RT4, der er specialdesignet til denne anvendelse

Diamantbelagte instrumenter bliver mindre effektive

- Efterse diamantbelægningens tilstand og udskift instrumentet, hvis det er nødvendigt



FEILSØKING

Problem	Løsning
Ingen eller lav irrigasjonsstrøm	<ul style="list-style-type: none">• Kontroller om instrumentet er tilstoppet. Blås trykkluft gjennom instrumentet for å fjerne tilstoppingen.• Bruk et annet håndstykke for å kontrollere om håndstykket er tilstoppet.• Hvis tilstoppingen ikke kan fjernes, må håndstykket sendes til et av EMS' godkjente reparasjonssentre.• Se bruksanvisningen for Piezon-produktet for mer informasjon.
Ingen ultralydsvingninger	<ul style="list-style-type: none">• Se bruksanvisningen for Piezon-produktet.
Dårligere eller redusert ytelse	<ul style="list-style-type: none">• Følg instruksjonene i bruksanvisningen for Piezon-produktet.• Kontroller at instrumentet er riktig plassert, stram det til igjen med CombiTorque.• Kontroller instrumentet med tanke på slitasje, og skift det ut ved behov.• Prøv å bruke håndstykket med et annet instrument.• Send håndstykket og instrumentet til et av EMS' godkjente reparasjonssentre.
Brekking av en fil eller et instrument, muligens inne i kaviteten eller rotkanalen	<ul style="list-style-type: none">• Kontroller at alle brukne deler er lokalisert.• Sammenligne de brukne delenes total lengde med lengden på en ny fil eller et nytt instrument for å sikre at alle brukne deler er til stede.• Prøv å fjerne brukne deler inne i rotkanalen ved å aktivere maksimal irrigasjon (ingen ultralyd) på en fil for å prøve å tvinge løse deler ut.• Se bruksanvisningene og bruk RT2-, RT3- og RT4-instrumenter som er spesialdesignet for dette.
Diamantbelagte instrumenter blir mindre effektive	<ul style="list-style-type: none">• Kontroller diamantbelegget visuelt og skift ut instrumentet ved behov.





EMS Electro Medical Systems SA



Chemin de la Vuarpillière 31
CH-1260 Nyon
Tel. +41 22 99 44 700
Fax +41 22 99 44 701
Contact: ems-dental.com/contact

EMS worldwide offices (dental)

MUNICH, GERMANY
EMS ELECTRO MEDICAL SYSTEMS GMBH
Schatzbogen 86
DE-81829 München
Tel. +49 89 42 71 61 0
Fax +49 89 42 71 61 60
e-mail: info@ems-ch.de

FONCINE, FRANCE
EMS ELECTRO MEDICAL SYSTEMS
FRANCE SARL
32, Route de Pontarlier
FR-39460 Foncine-le-Haut
Tel. +33 3 84 51 90 01
Fax +33 3 84 51 94 01
e-mail: info@ems-france.fr

MADRID, SPAIN
EMS ELECTRO MEDICAL SYSTEMS
ESPAÑA SLU
C/ Tomás Bretón, 50-52 2ª planta
ES-28045 Madrid
Tlf. +34 91 528 99 89
e-mail: info@ems-espana.com

MILANO, ITALY
EMS ITALIA S.R.L.
Via Faravelli 5
IT-20149 Milano
Tel. +39 02 3453 8111
e-mail: dental@ems-italia.it

KATOWICE, POLAND
EMS POLAND SP. Z O.O.
Al. Różdzieńskiego 188H
PL-40-203 Katowice
Tel. +48 32 4937060
e-mail: info@ems-poland.com

SHANGHAI, CHINA
医迈斯电子医疗系统贸易 (上海) 有限公司
E.M.S. ELECTRO MEDICAL SYSTEMS
TRADING (SHANGHAI) CO., LTD.
24A, Jin Sui Mansion,
N°379 Pudong Nan Rd.
CN-Shanghai 200120
Tel. +86 21 3363 2323
e-mail: emschina@ems-ch.com

DALLAS, USA
EMS CORPORATION
11886 Greenville Avenue, ste. 120
US-Dallas, Texas 75243
Phone : +001 972 690 8382
Fax : +001 972 690 8981
E-mail : info@ems-na.com

TOKYO, JAPAN
E.M.S. JAPAN BRANCH OFFICE
5F, 4-6-5 Nihombashi-Muromachi, Chuo-ku
JP-103-0022 Tokyo
Phone : +81 (0) 3 3278 0375
Fax : +81 (0) 3 3278 0376
E-mail : emsjapan@ems-ch.com

SYDNEY, AUSTRALIA
E.M.S. ELECTRO MEDICAL SYSTEMS
OCEANIA
Unit 1, Building 4 – Sydney Corporate Park
160 Bourke Road
AU-Alexandria, NSW 2015
Tel. +61 414 317 352
e-mail : info@ems-oceania.com

WWW.EMS-DENTAL.COM